

ÜGFİ

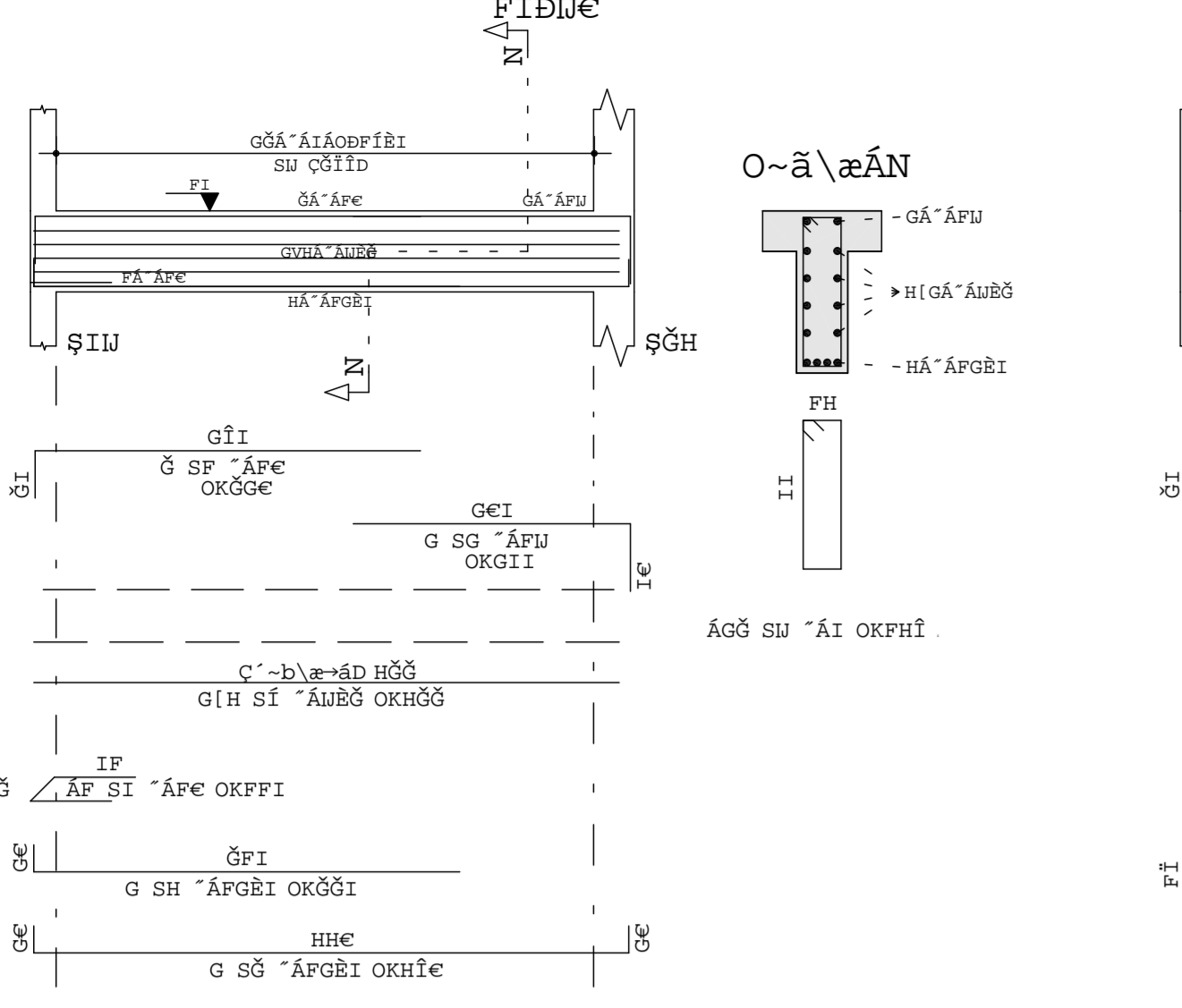

ÜGGĖ

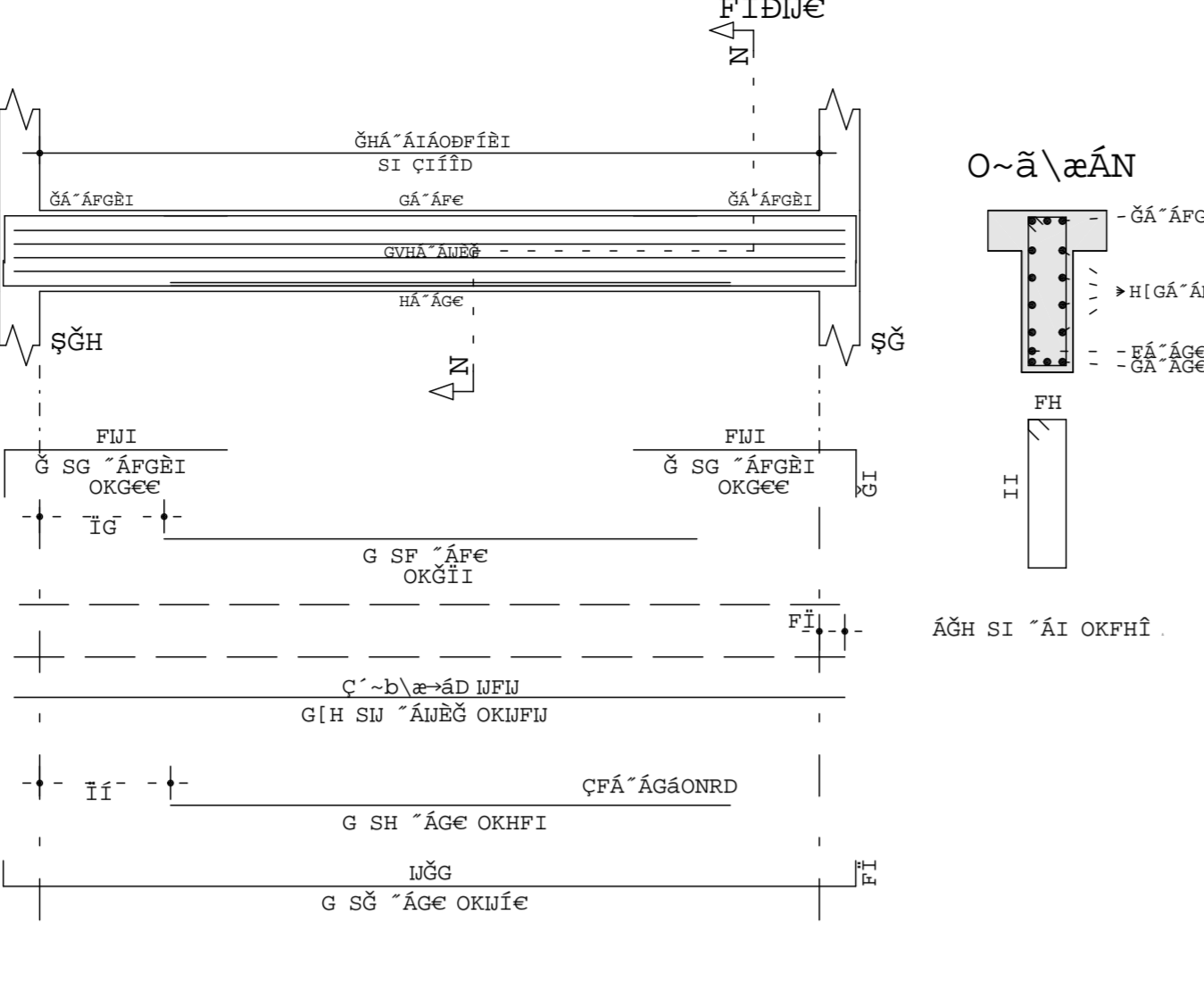

ÜGGĜ

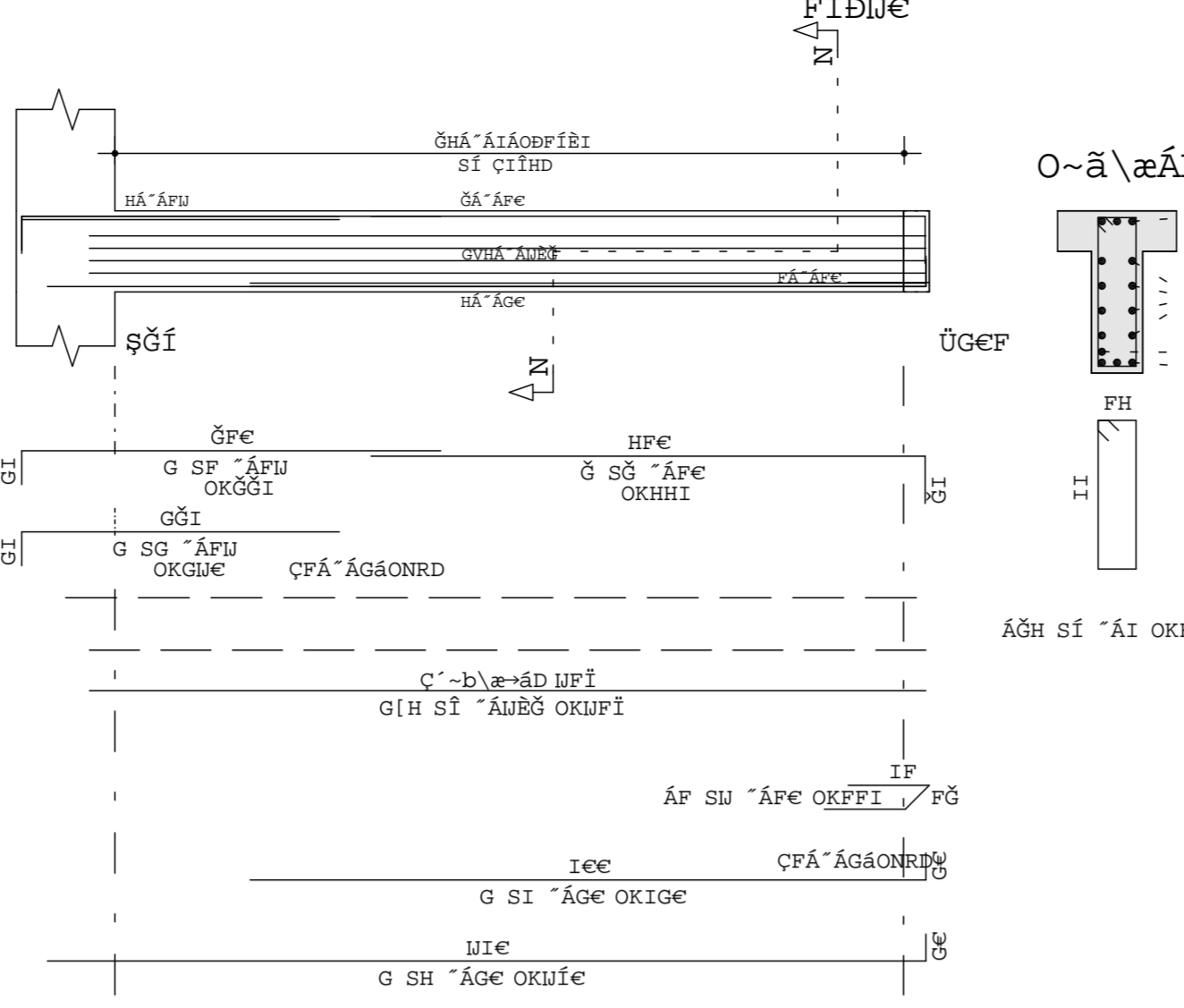

ÜGGĤ

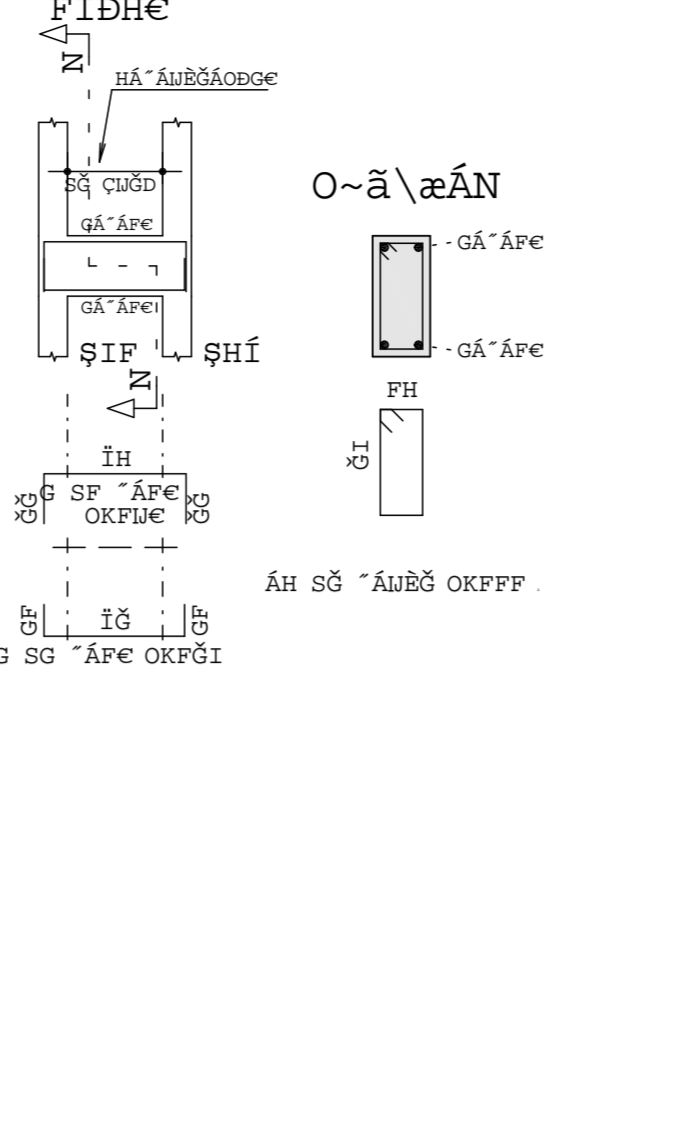

ÜGGİ

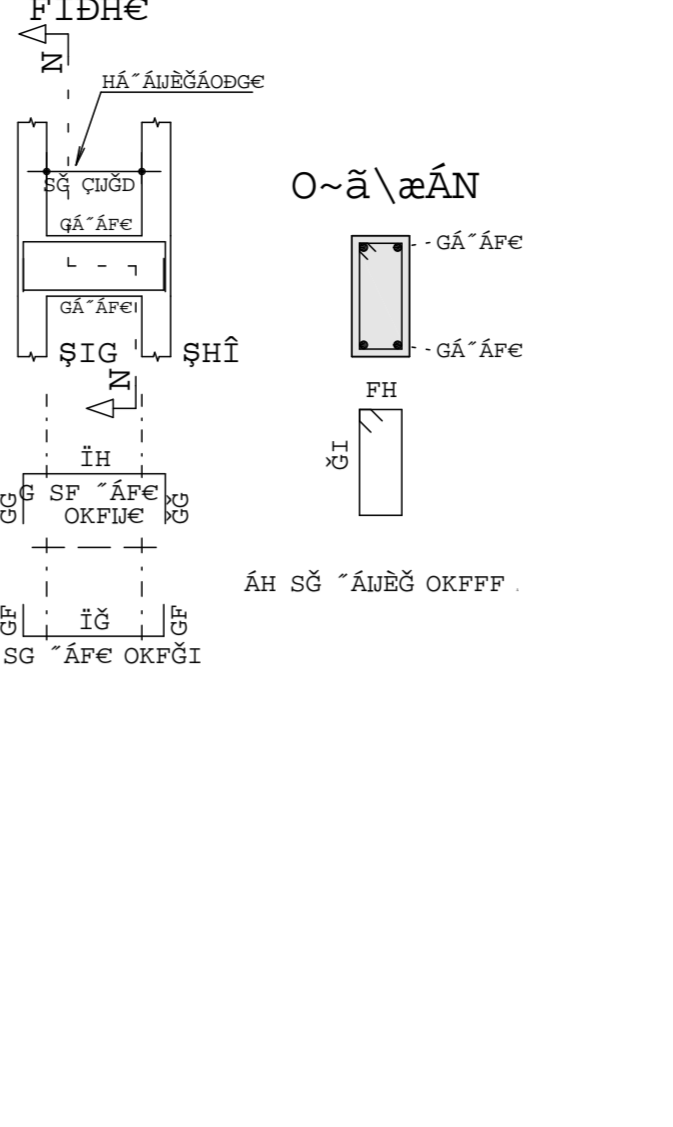

ÜGGÎ

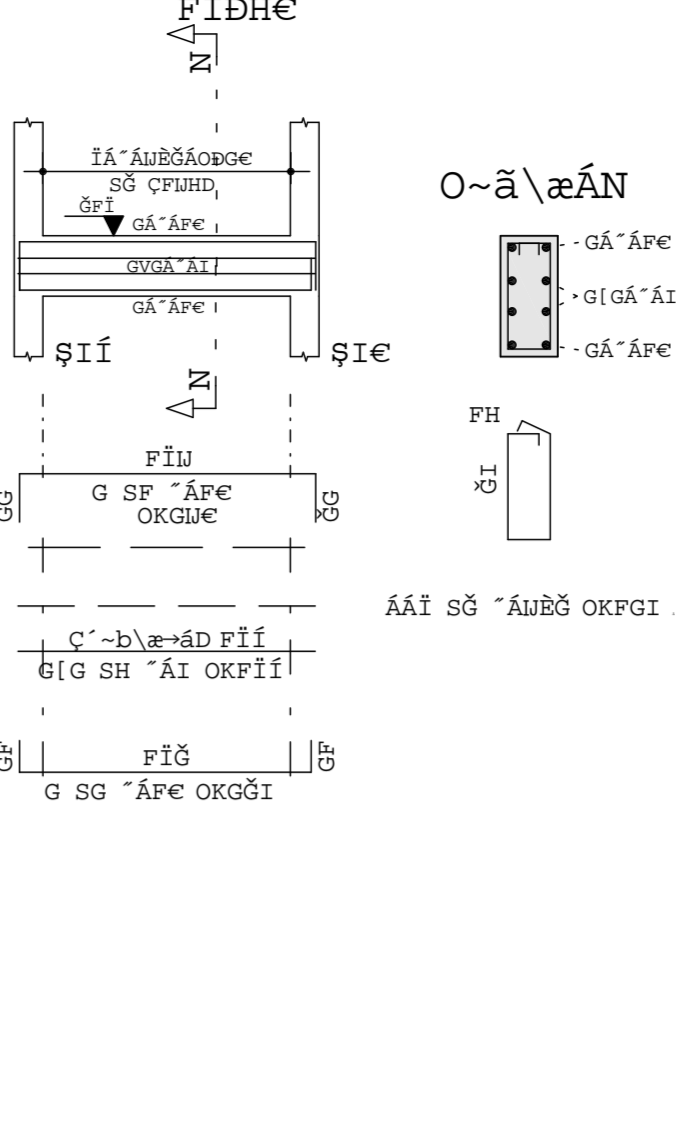

ÜGGĬ

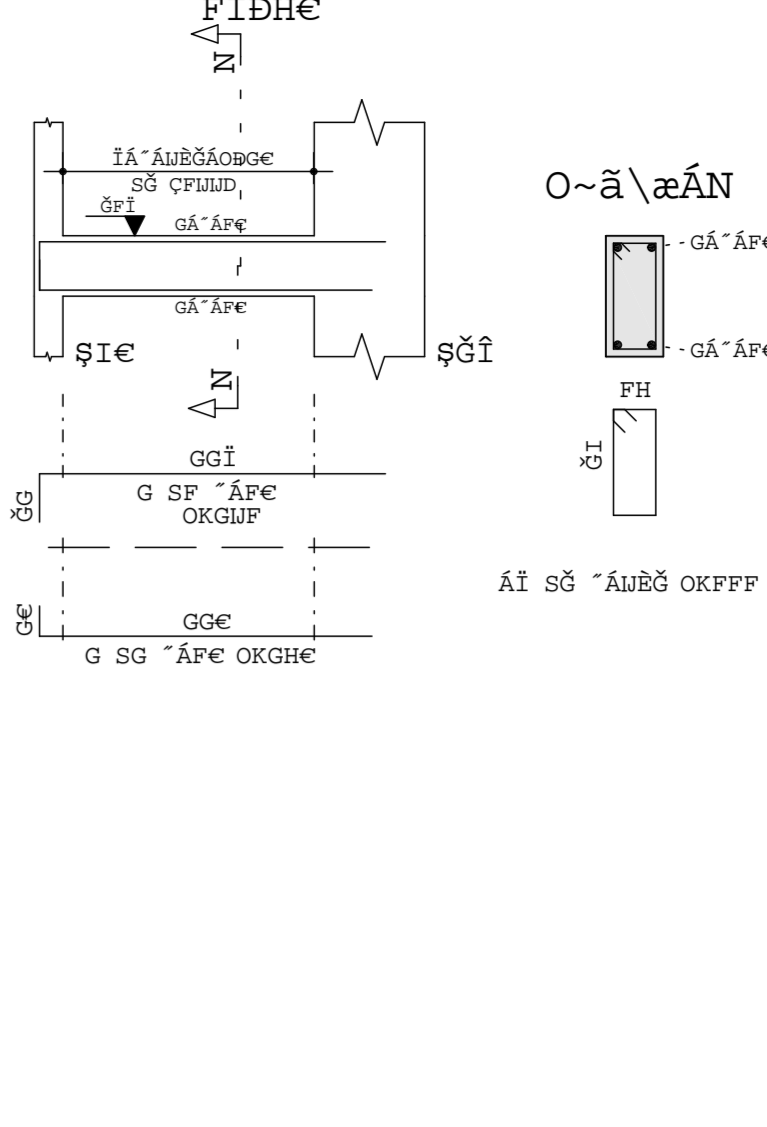

ÜGGİ

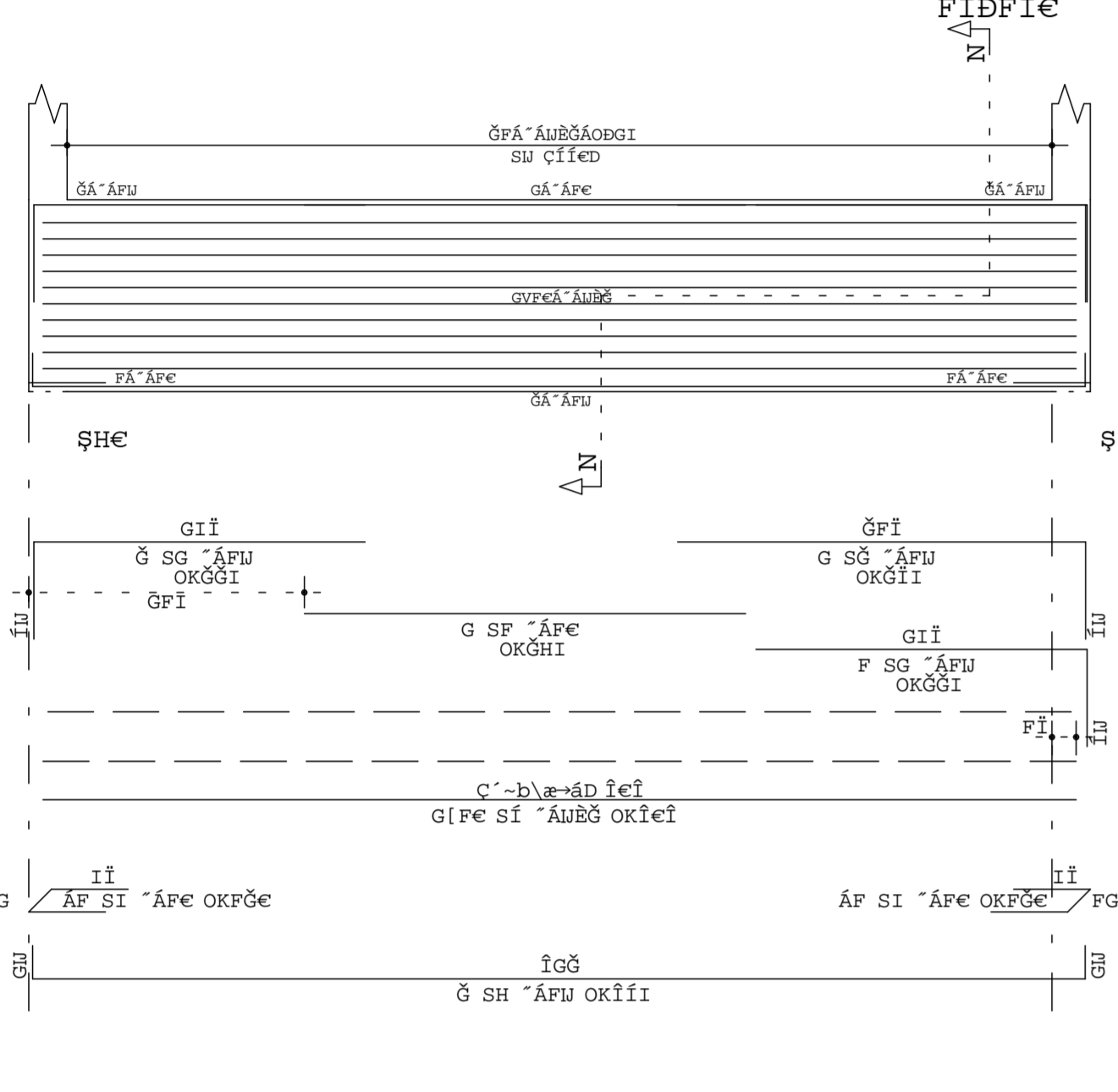

ÜGGĖ

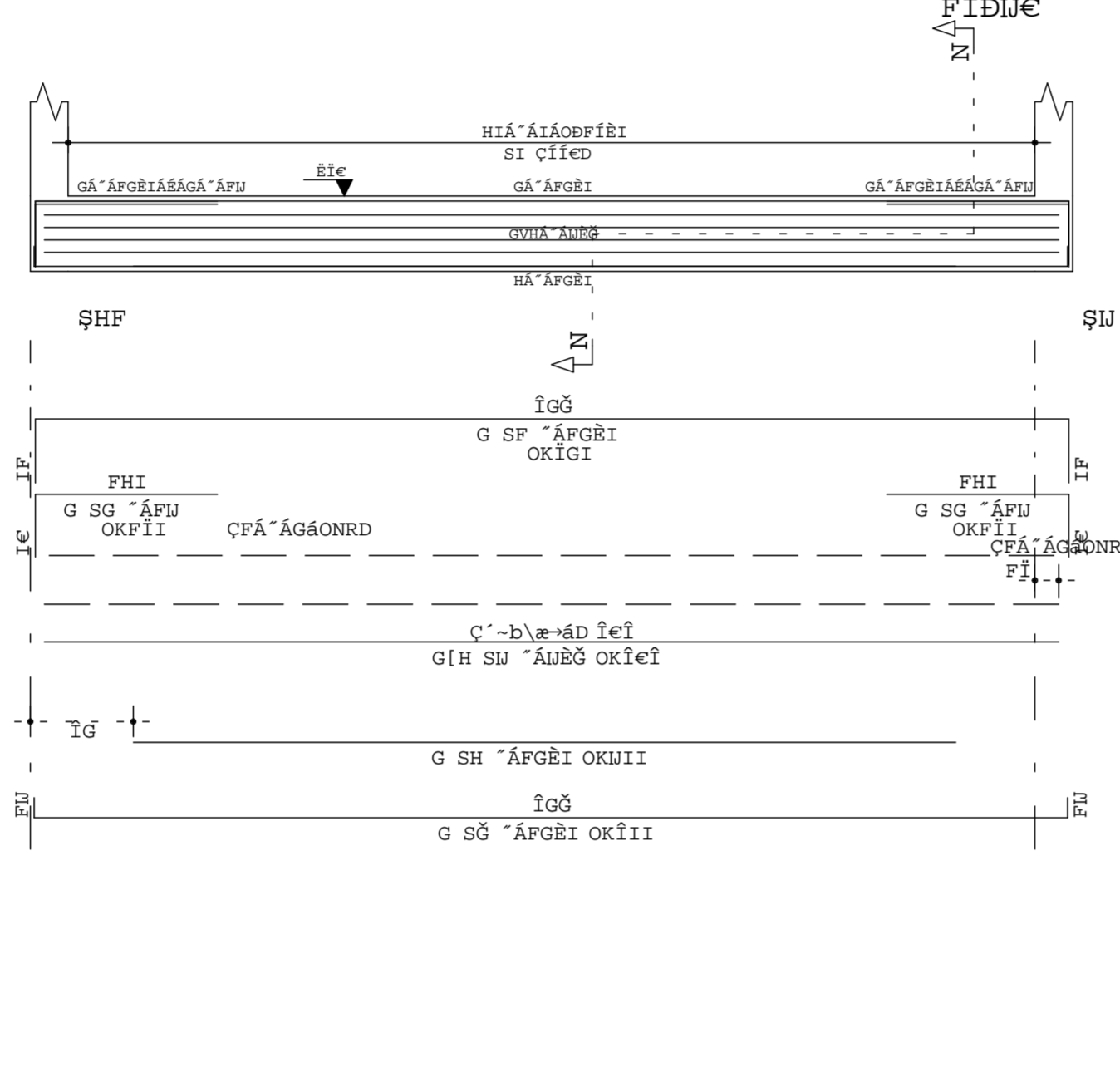

ÜGGĜ

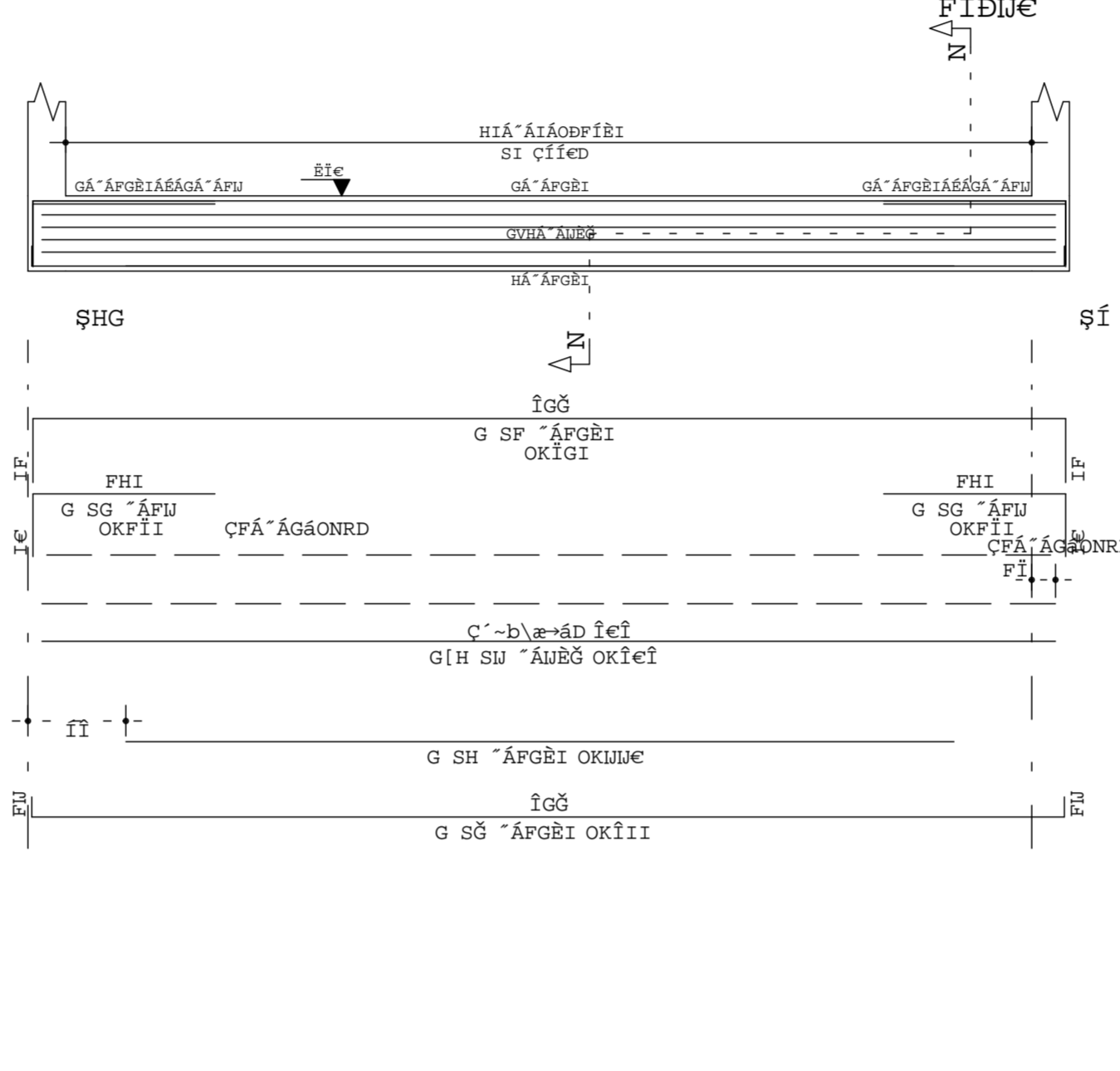

ÜGGĜ

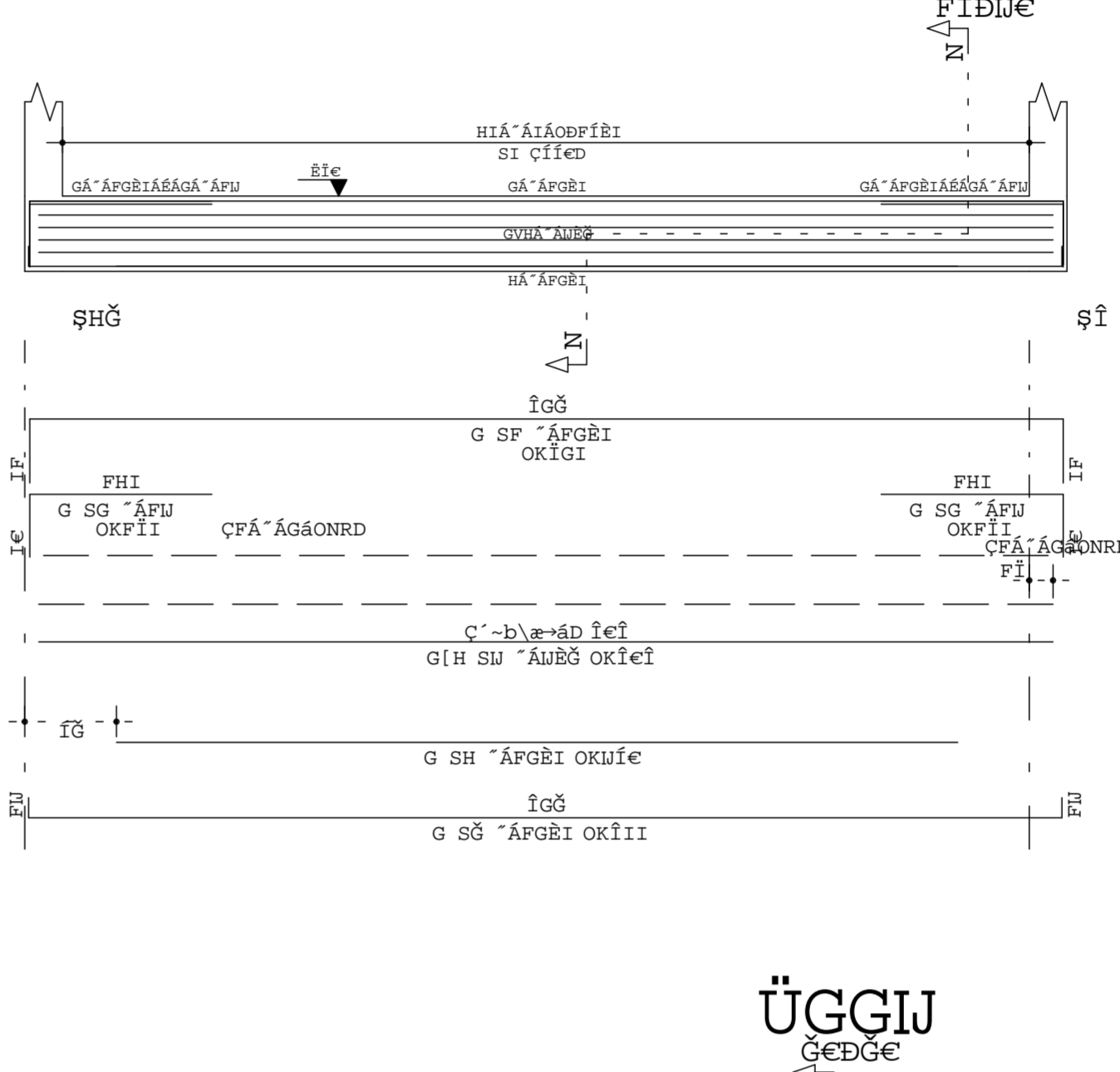

ÜGGĜ

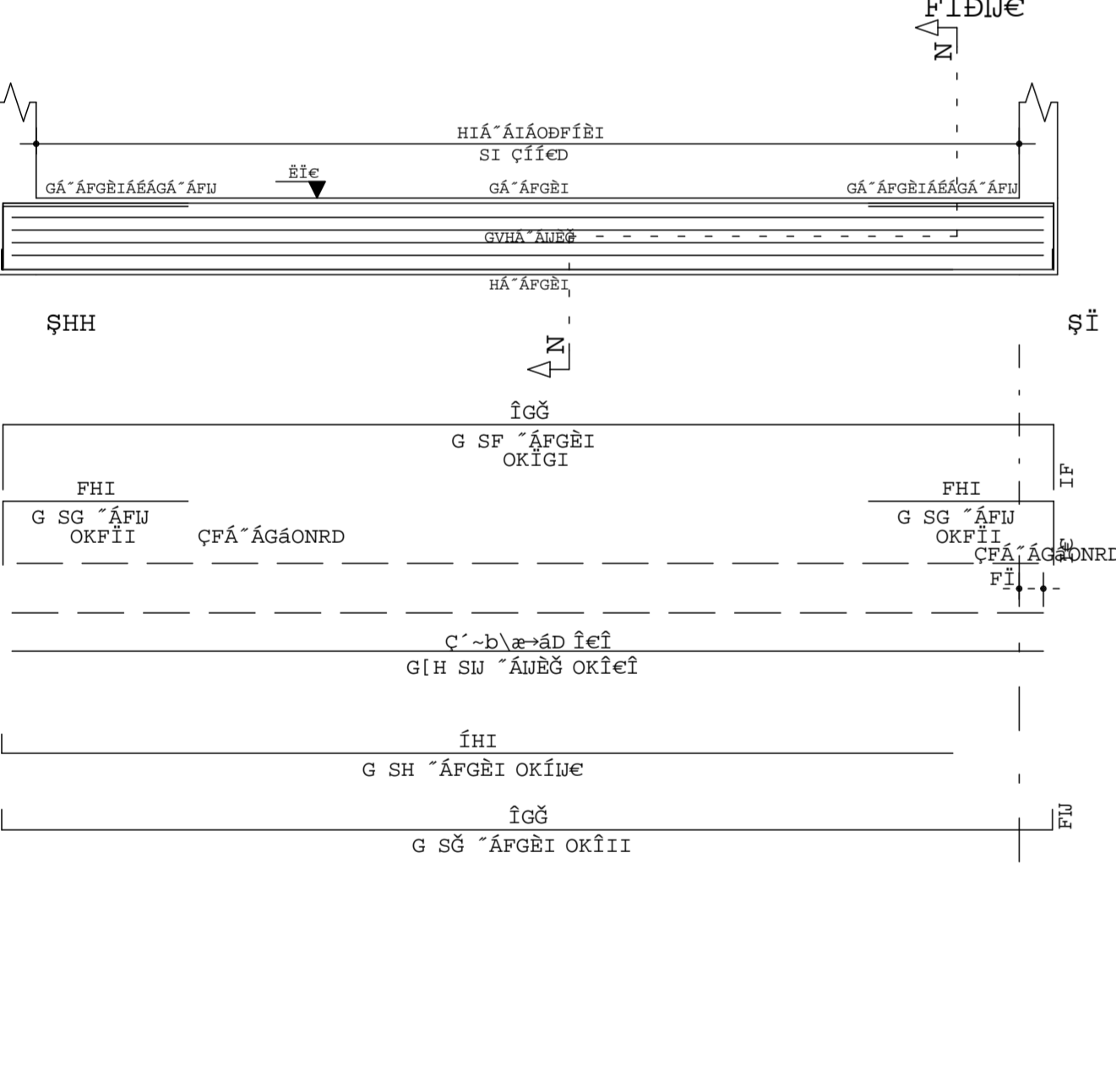

ÜGGĜ

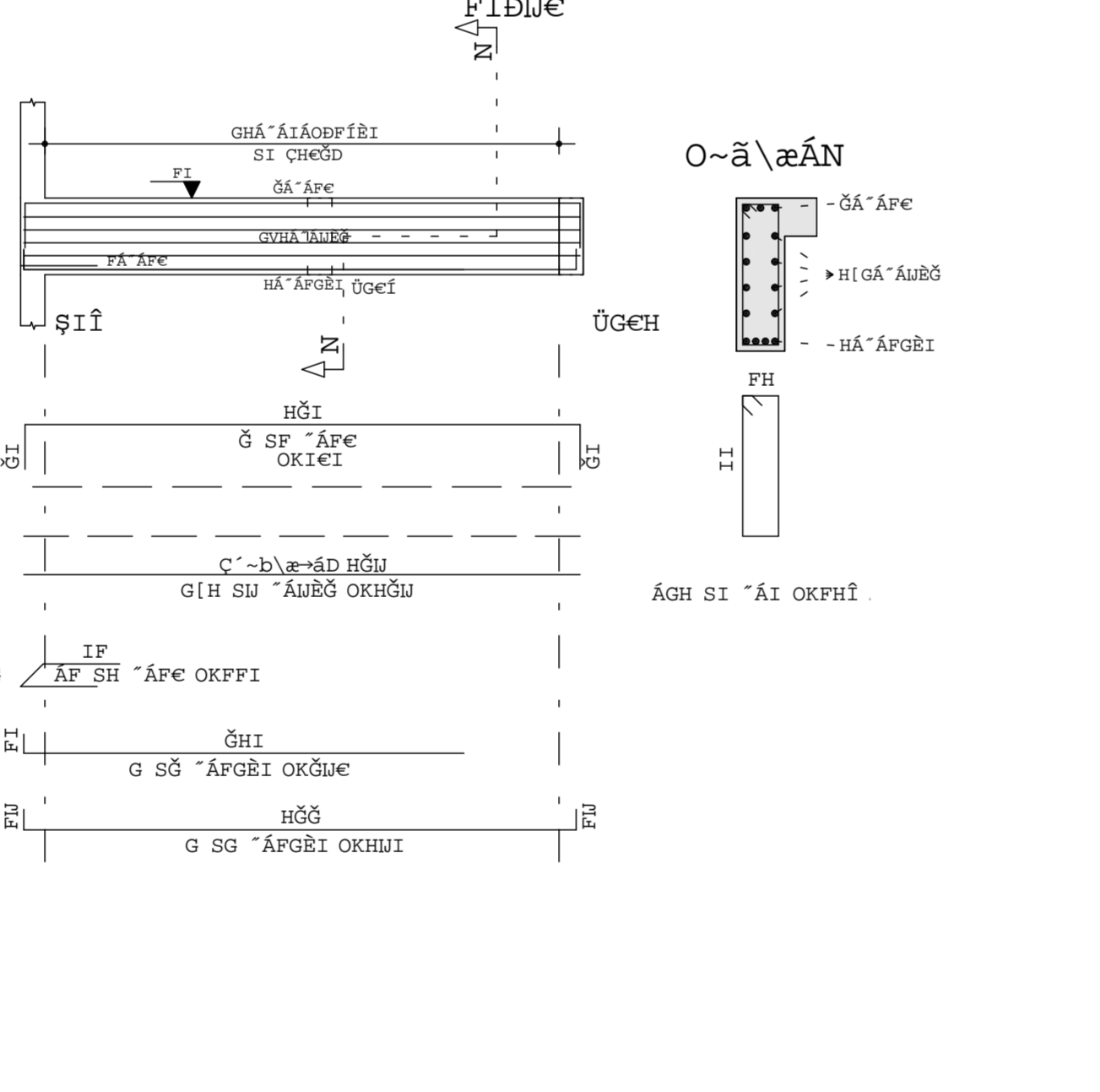

ÜGGĜ

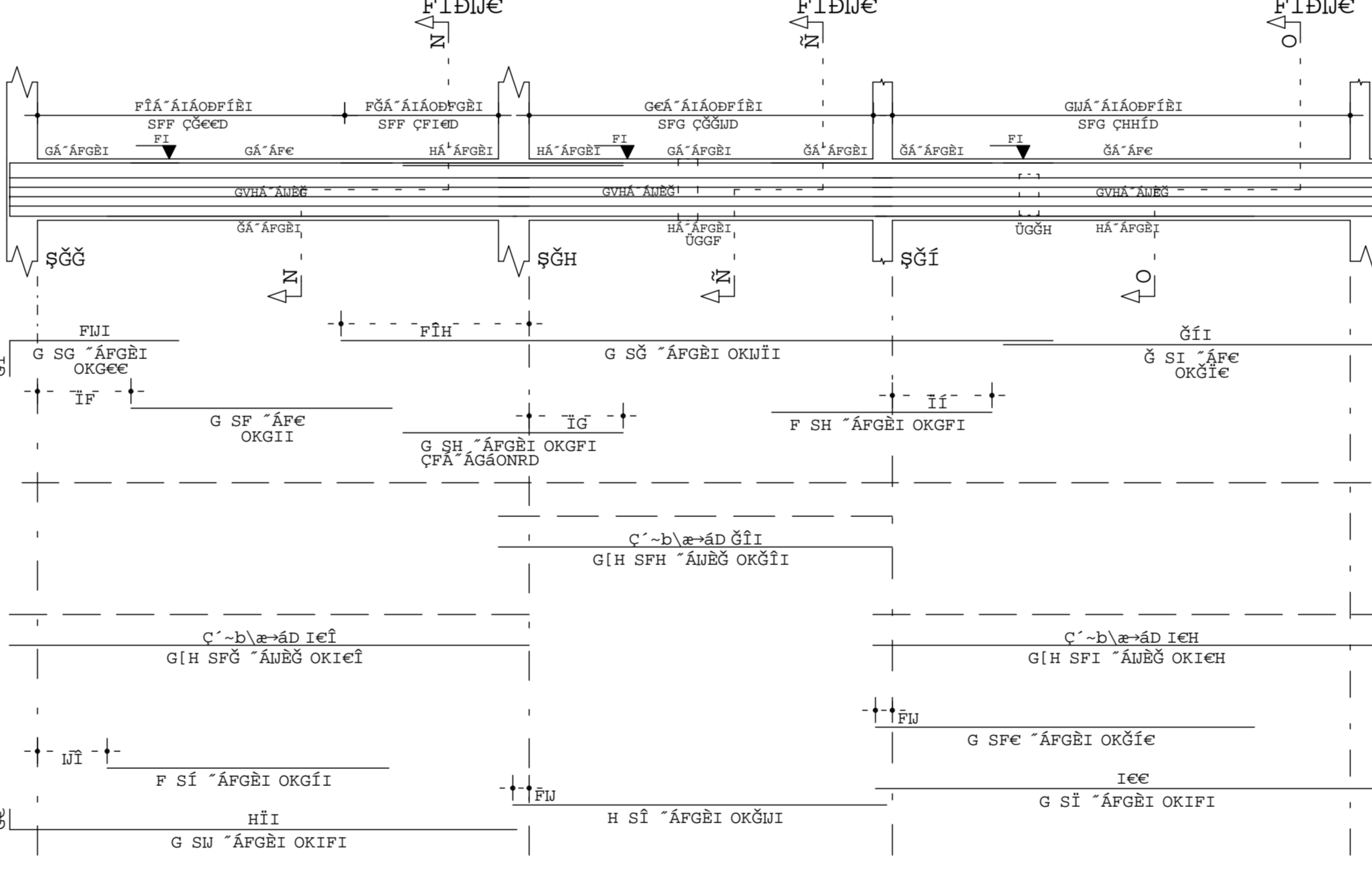

ÜGGĜ

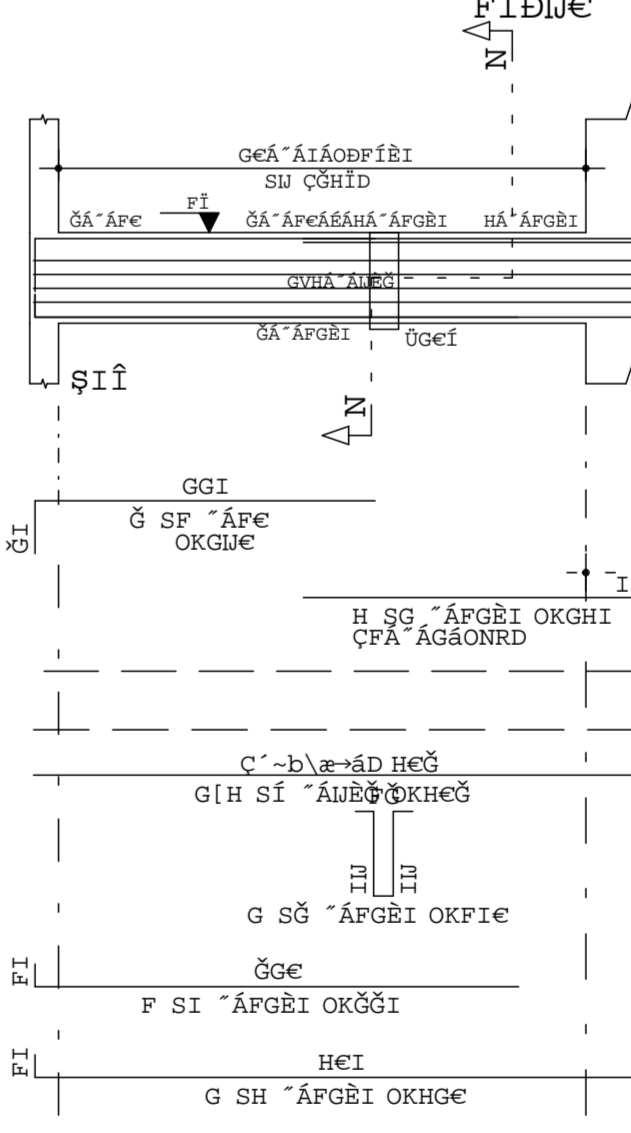

ÜGGĜ

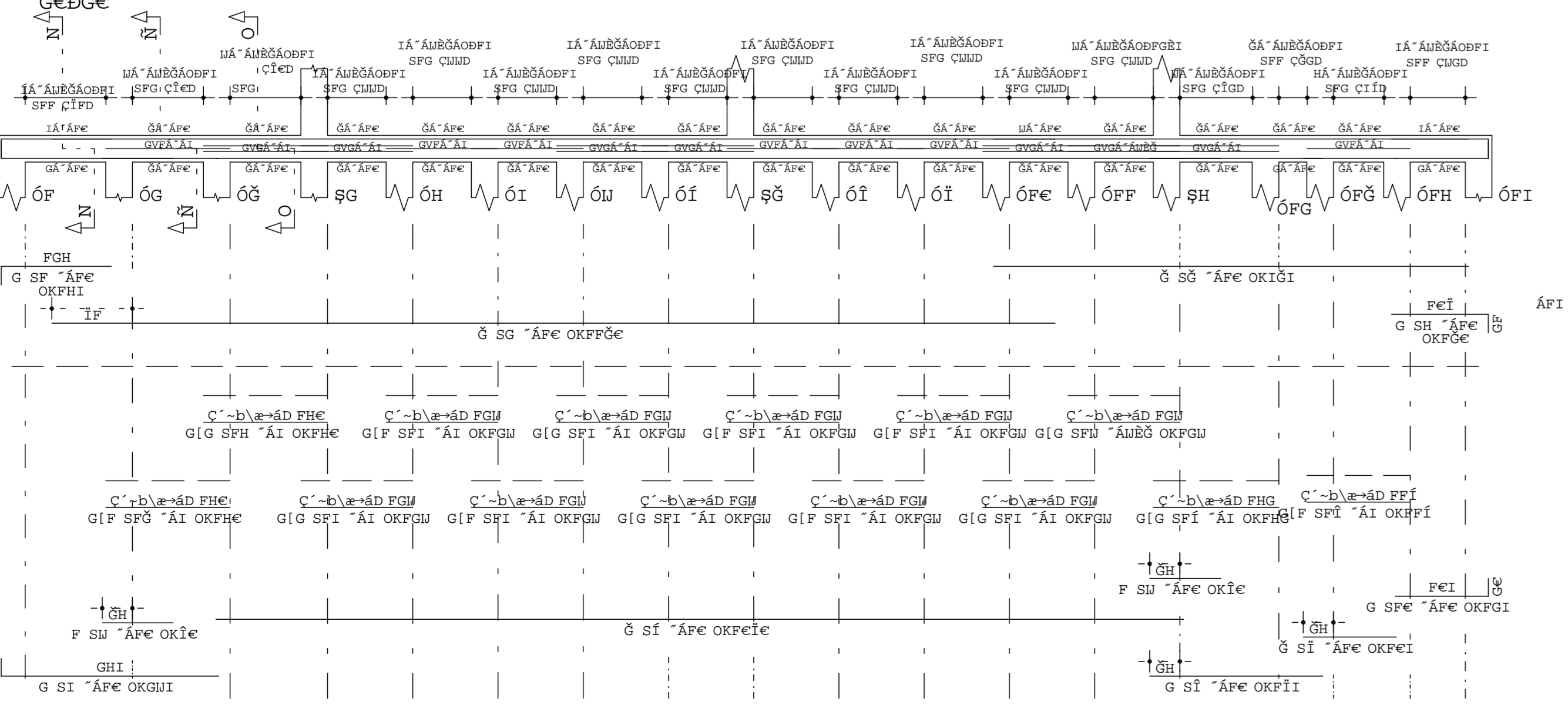

ÜGGĜ

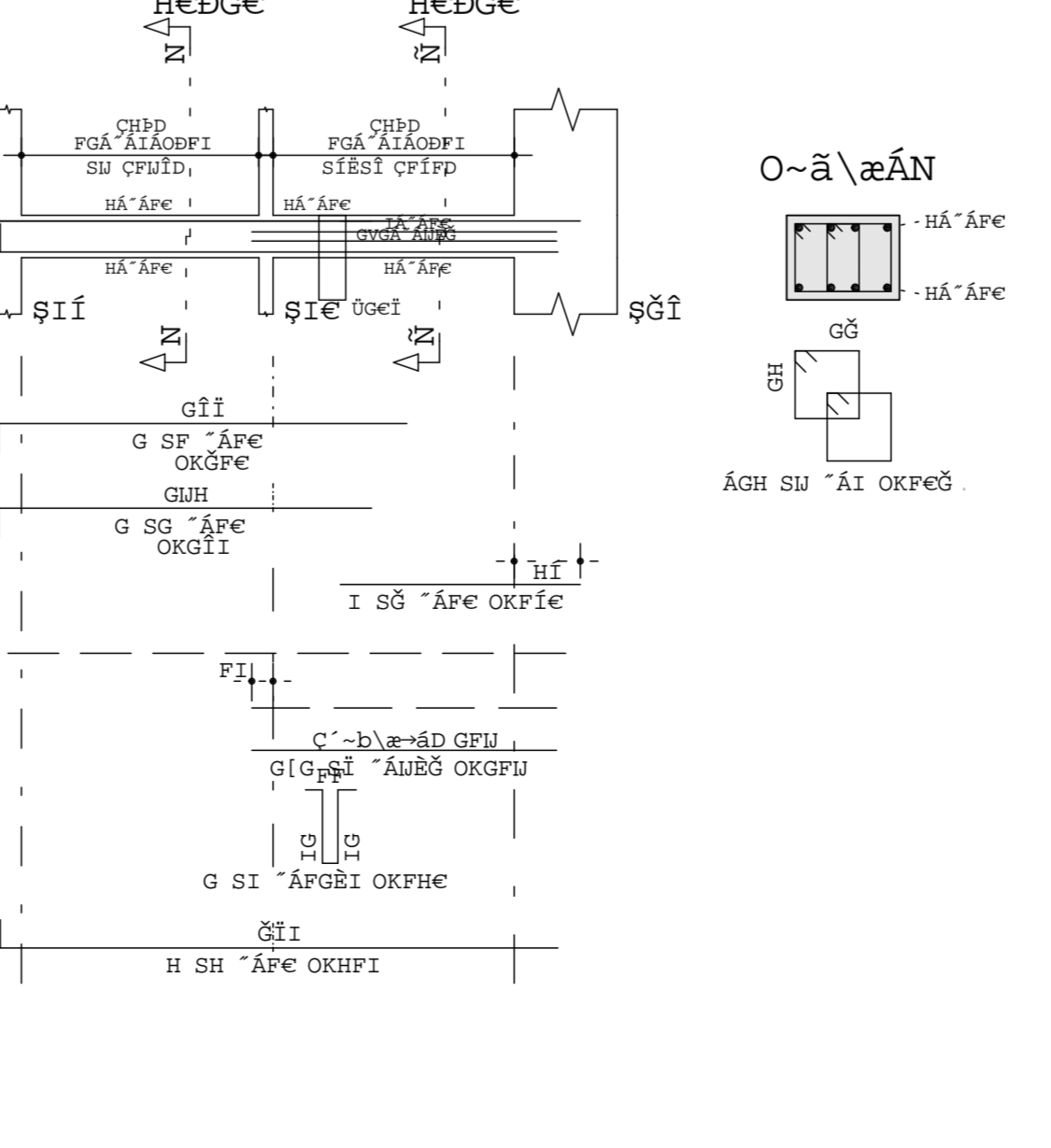

ÜGGĜ

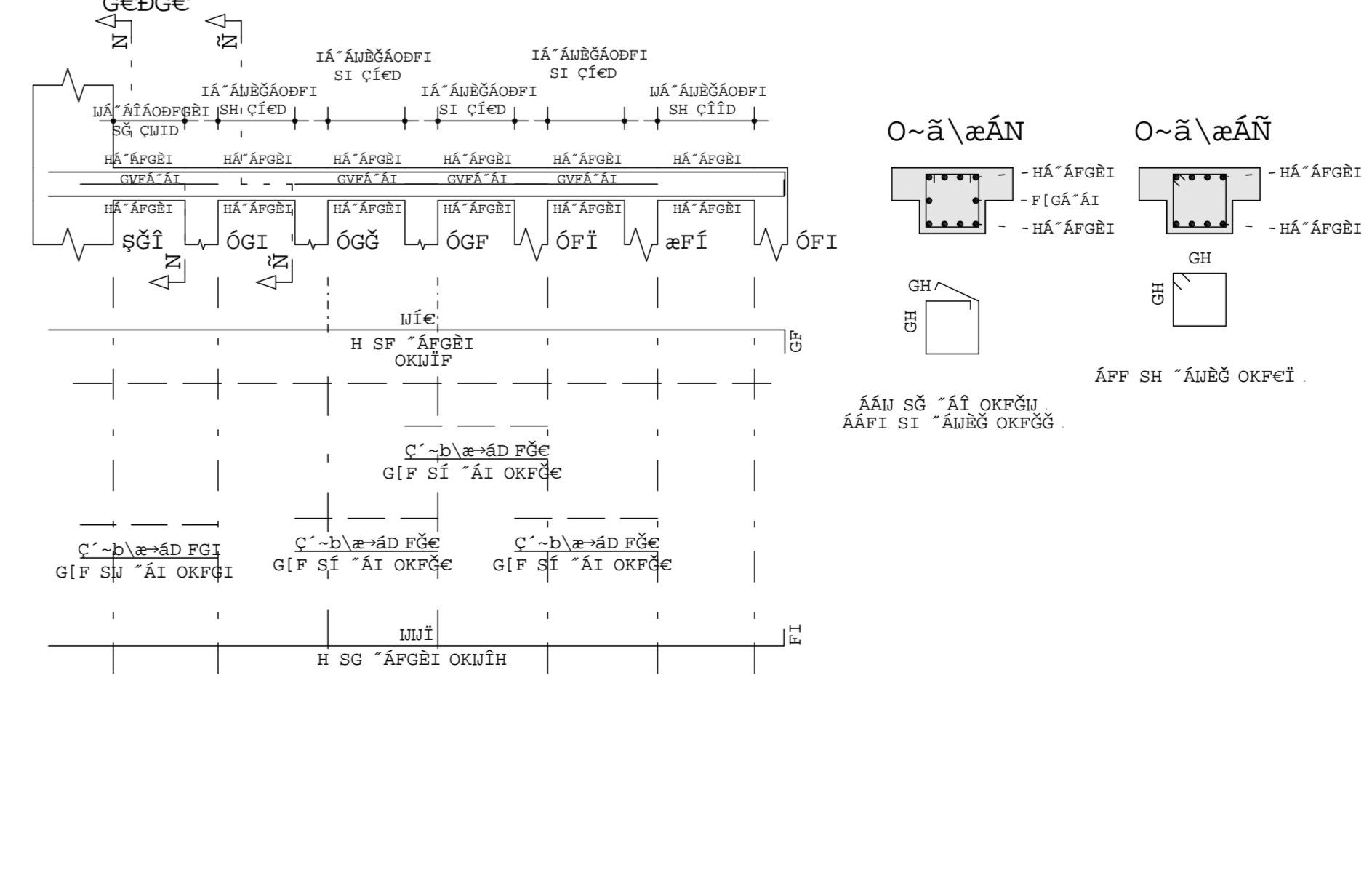

Table with 10 columns: NoS, SŞU, NŞU, TŞUNŞ, ÖŞŞÖŞ, ÖŞŞÖŞ, ÖŞŞÖŞ, ÖŞŞÖŞ. It contains musical notation and symbols for various ÜGGĜ variants.

Table with 4 columns: NoS, NŞU, ÖŞŞÖŞ, ÖŞŞÖŞ. It contains musical notation and symbols for various ÜGGĜ variants.

Complex block containing musical notation, a diagram of the 'O-ä\æÂN' symbol, and a table with 4 columns: NoS, NŞU, ÖŞŞÖŞ, ÖŞŞÖŞ.