

ÜHFÎ

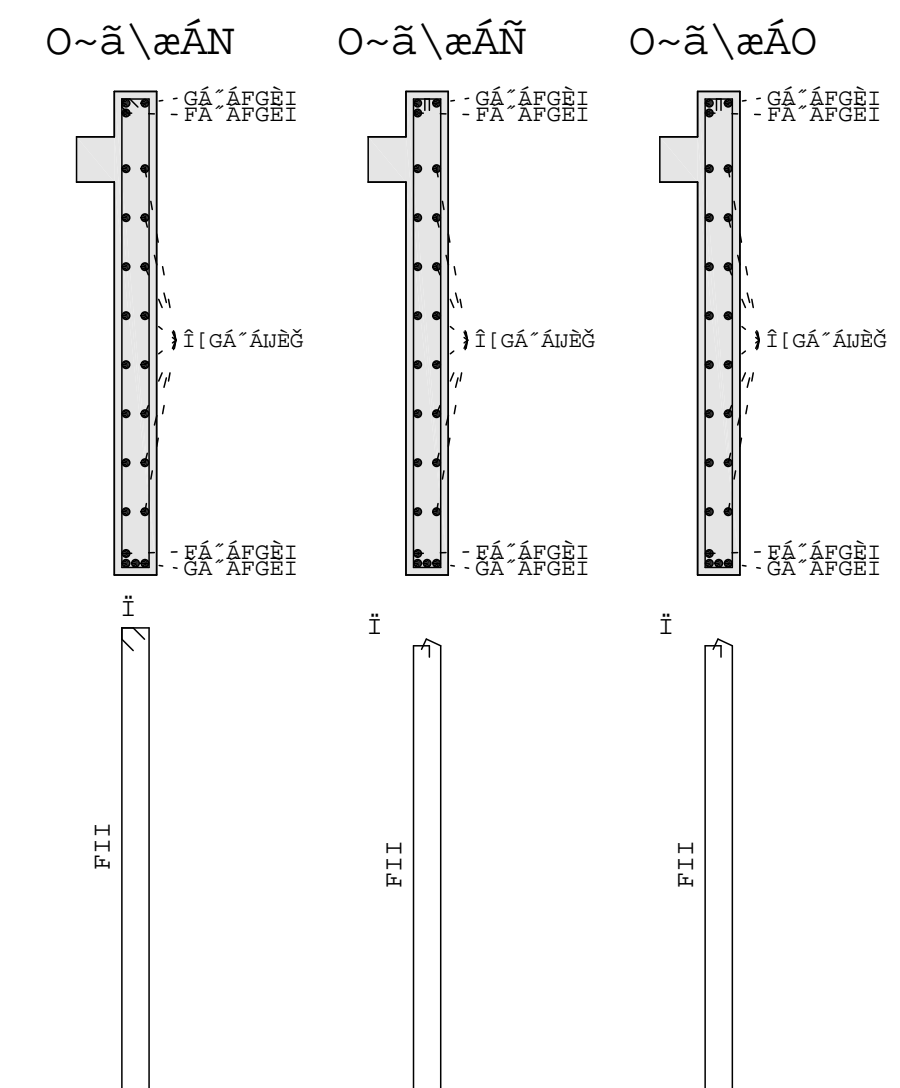

Äi sh "Äi okõõi" ÄÄi si "Äi okõhi" ÄÄi si "Äi okõhi"

ÜHGI

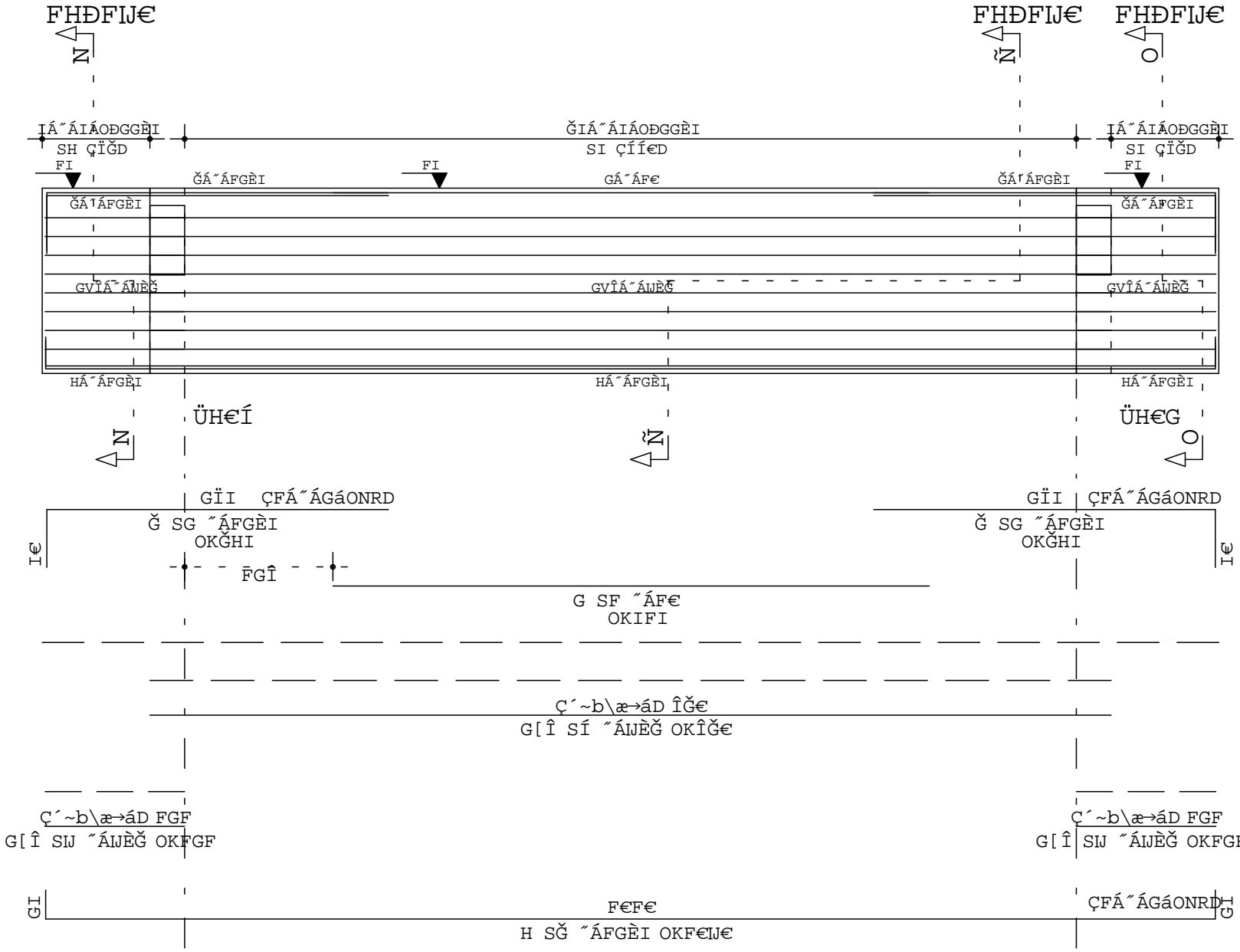
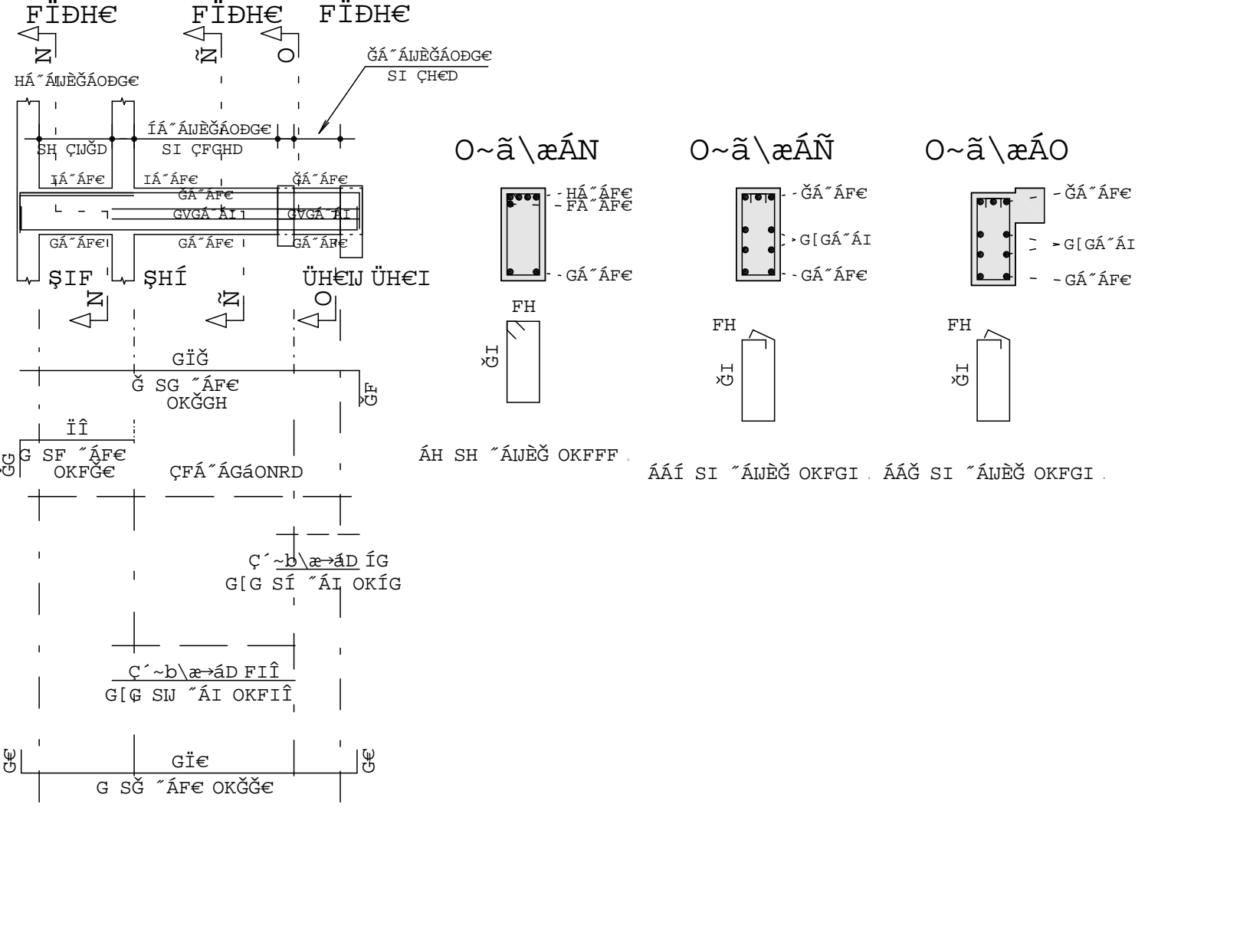

ÜHGU

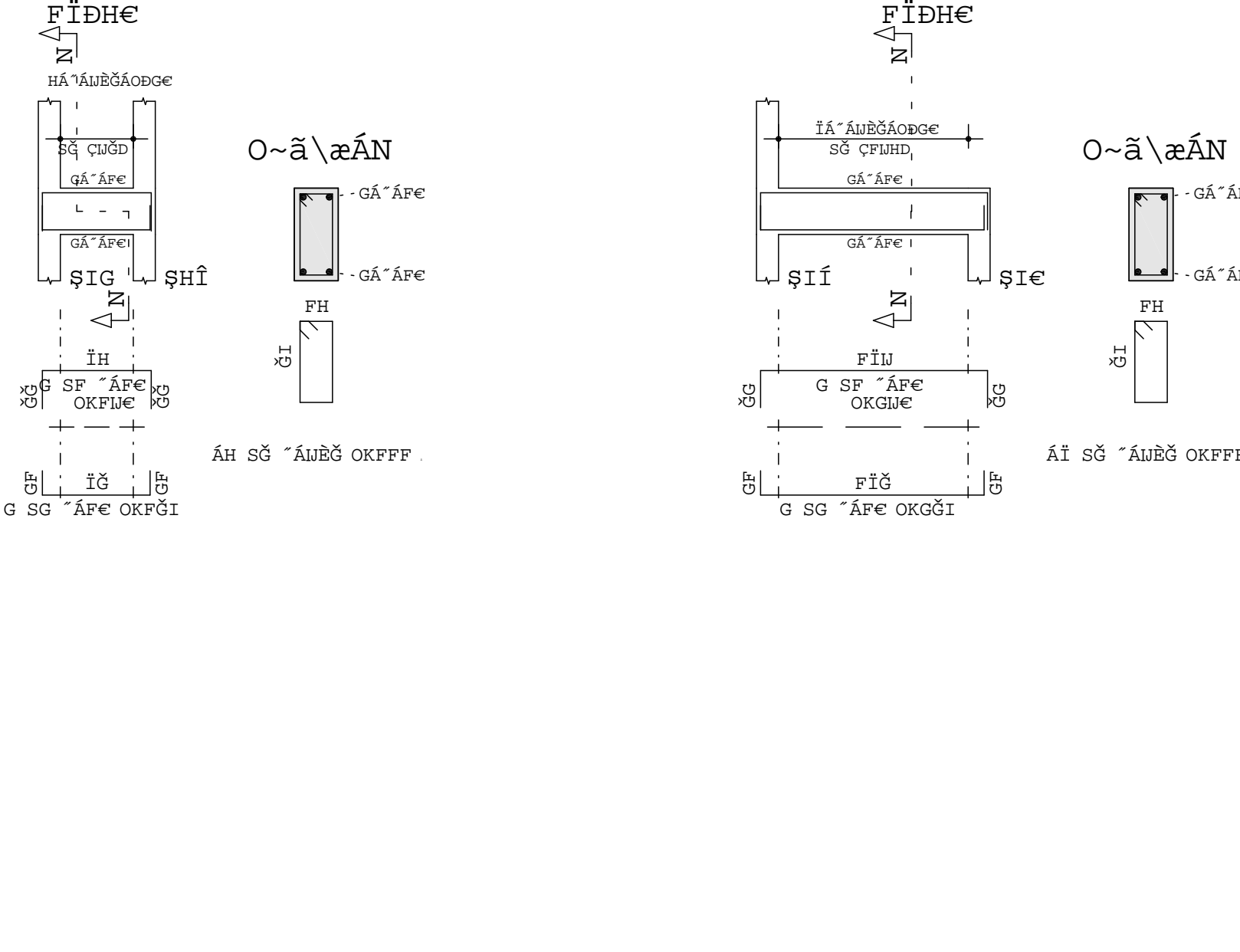

ÜHGÏ

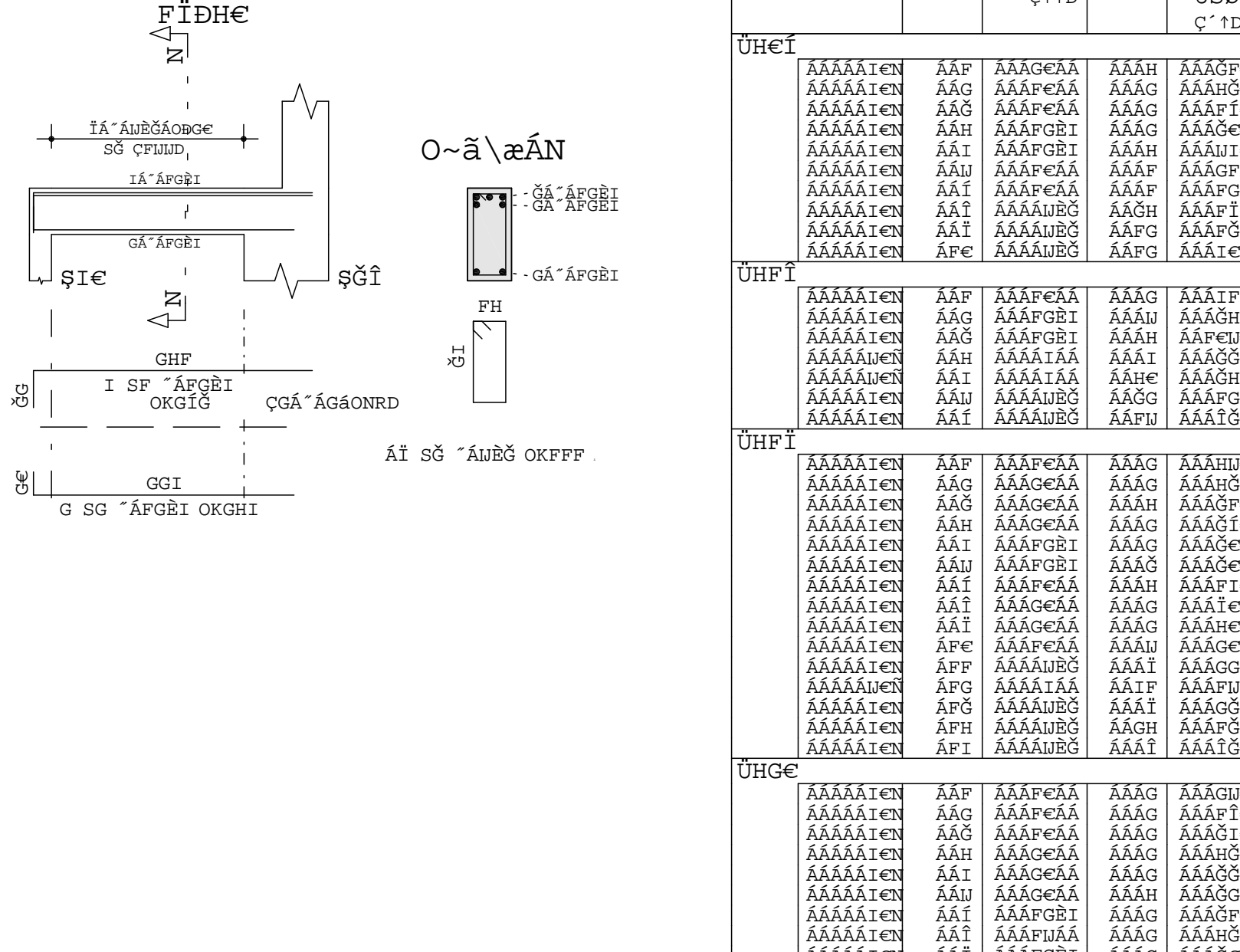

ÜHGU

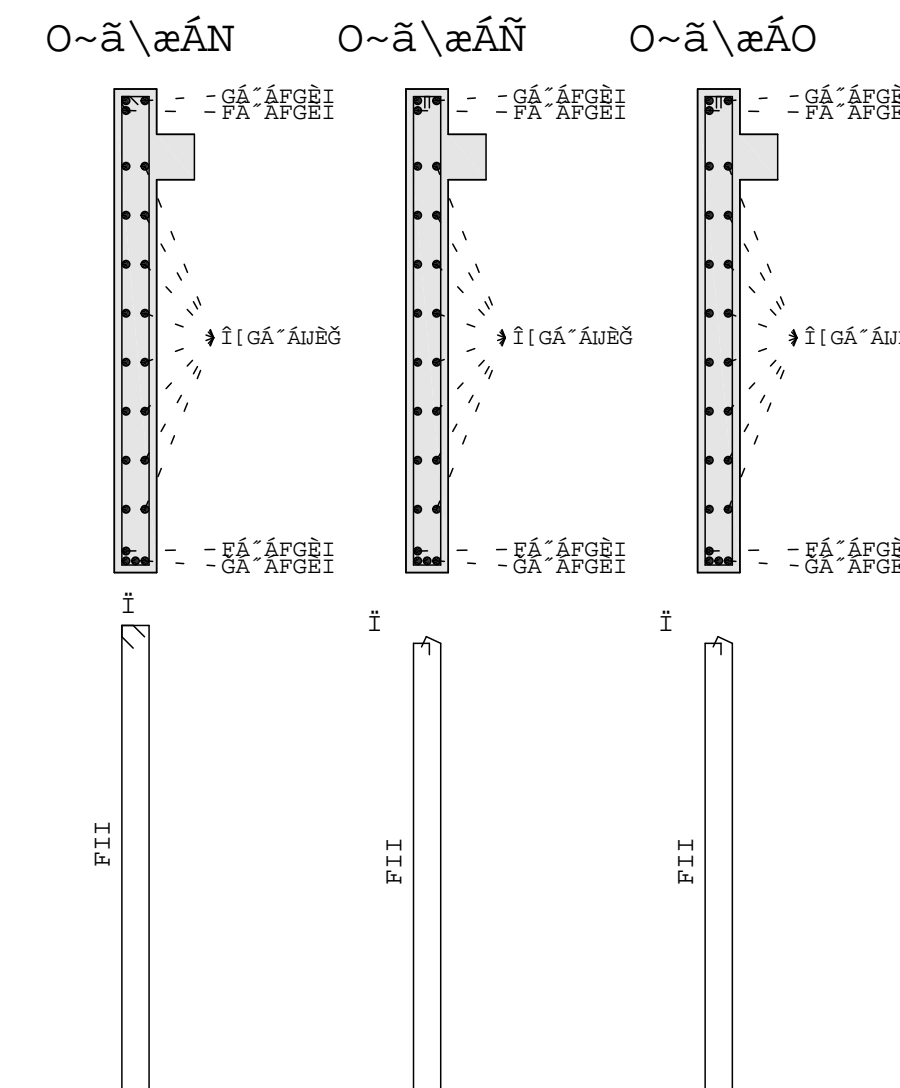
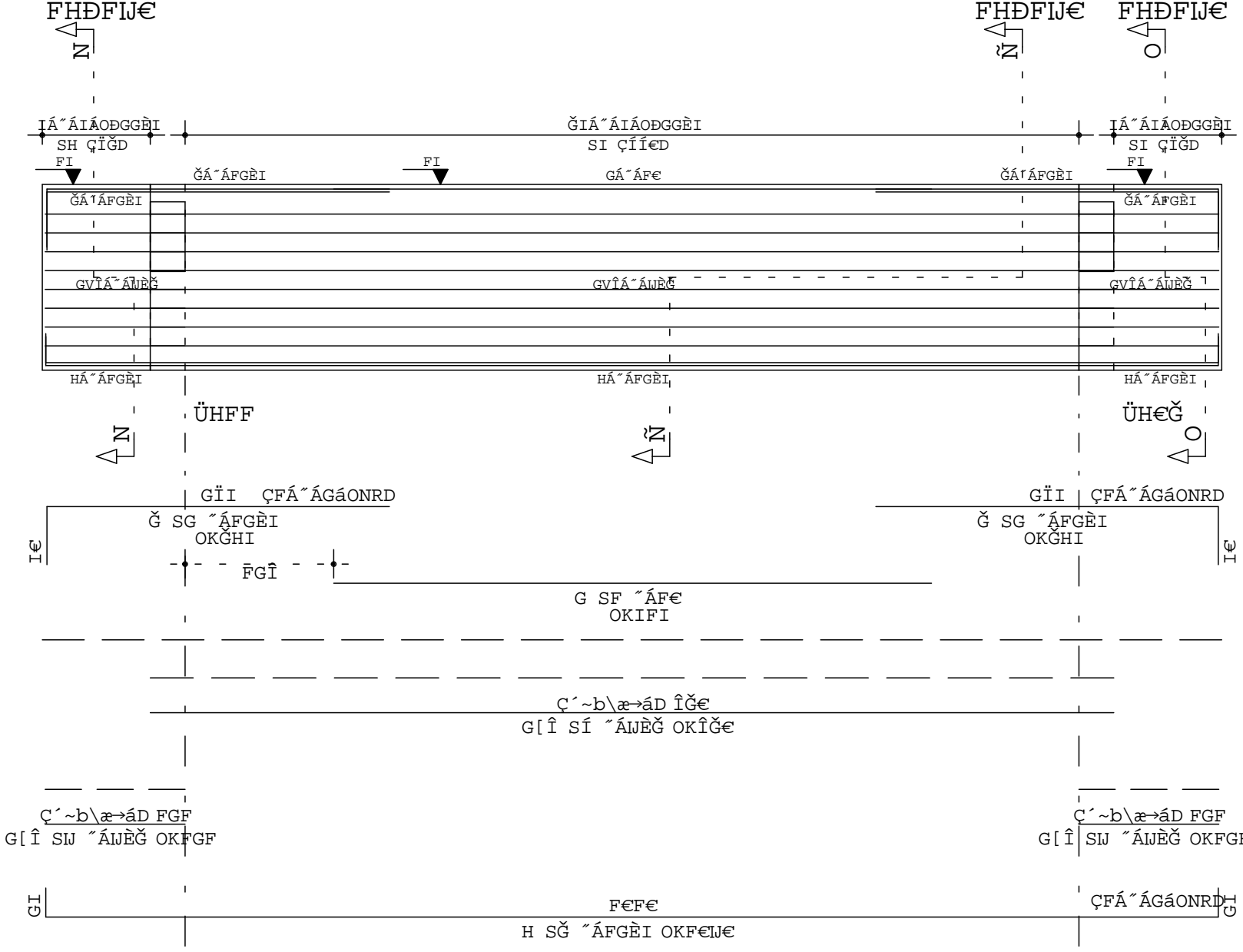

Äi sh "Äi okõõi" ÄÄi si "Äi okõhi" ÄÄi si "Äi okõhi"

ÜHEÏ

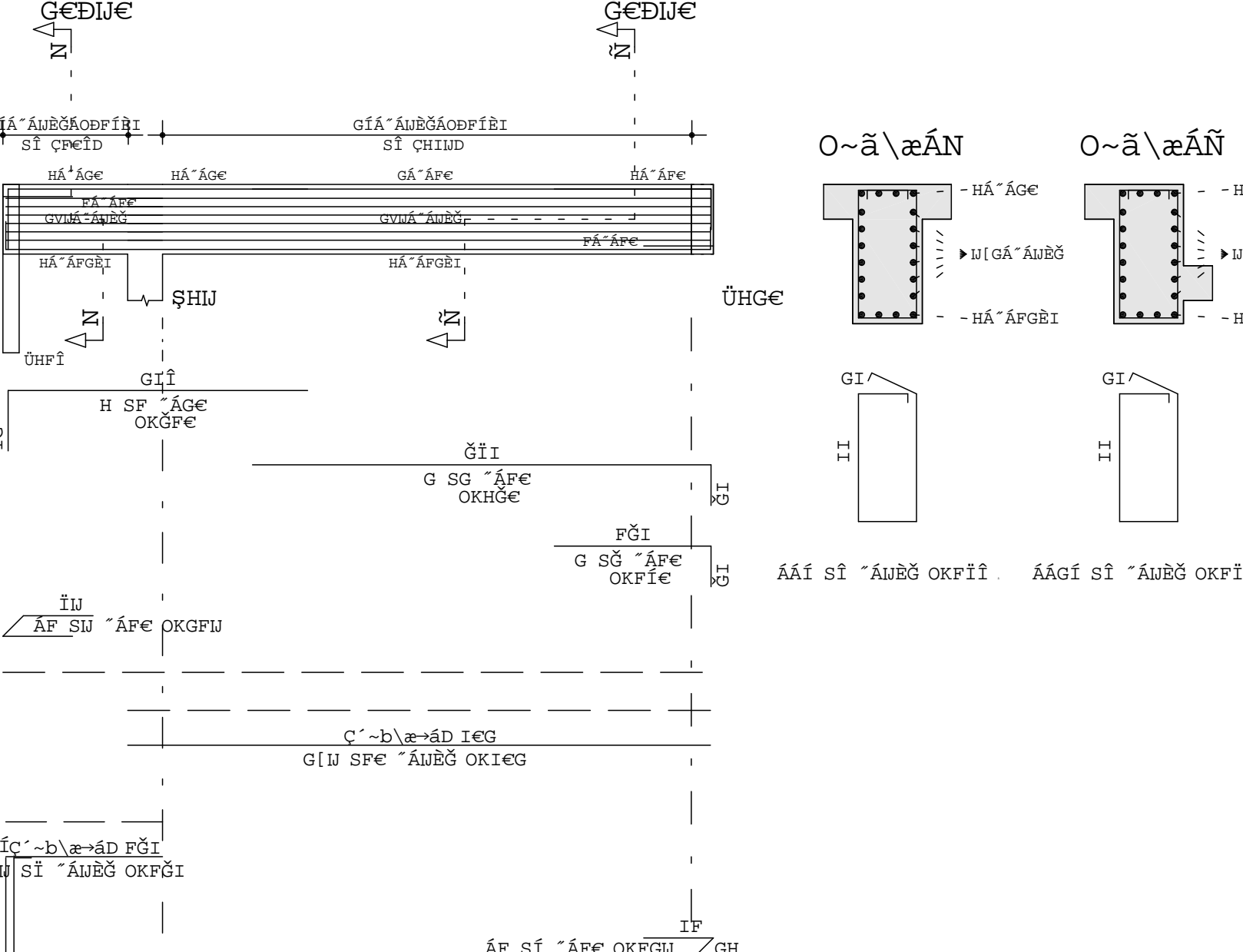

ÜHFÏ

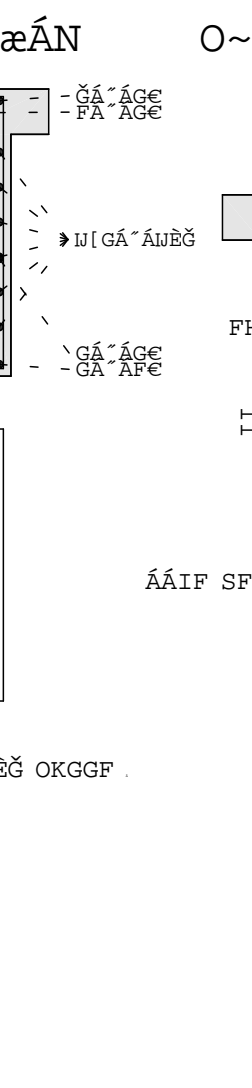
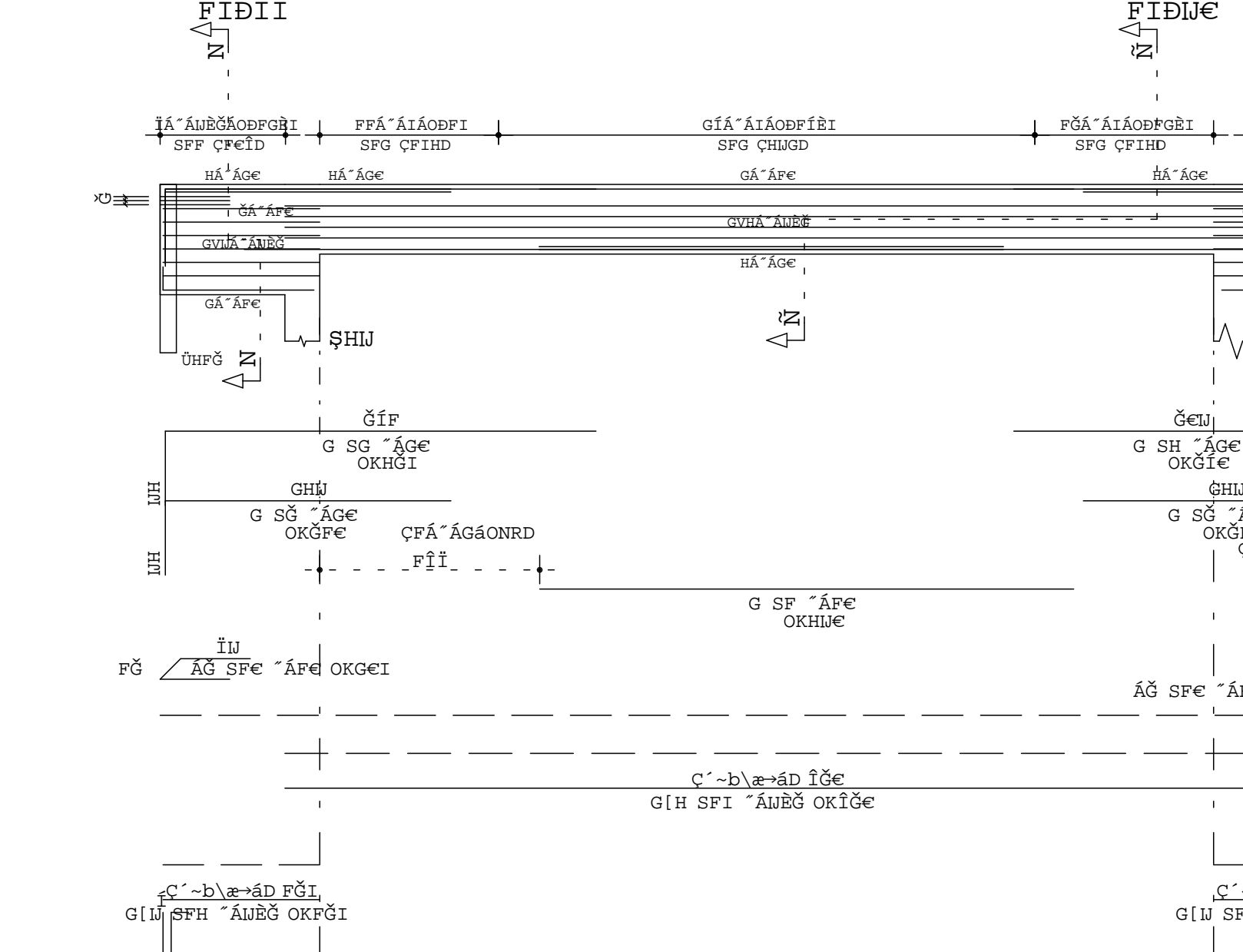

ÄÄi spõ "Äi okõõi" ÄÄi spõ "Äi okõõi"

ÜHGË

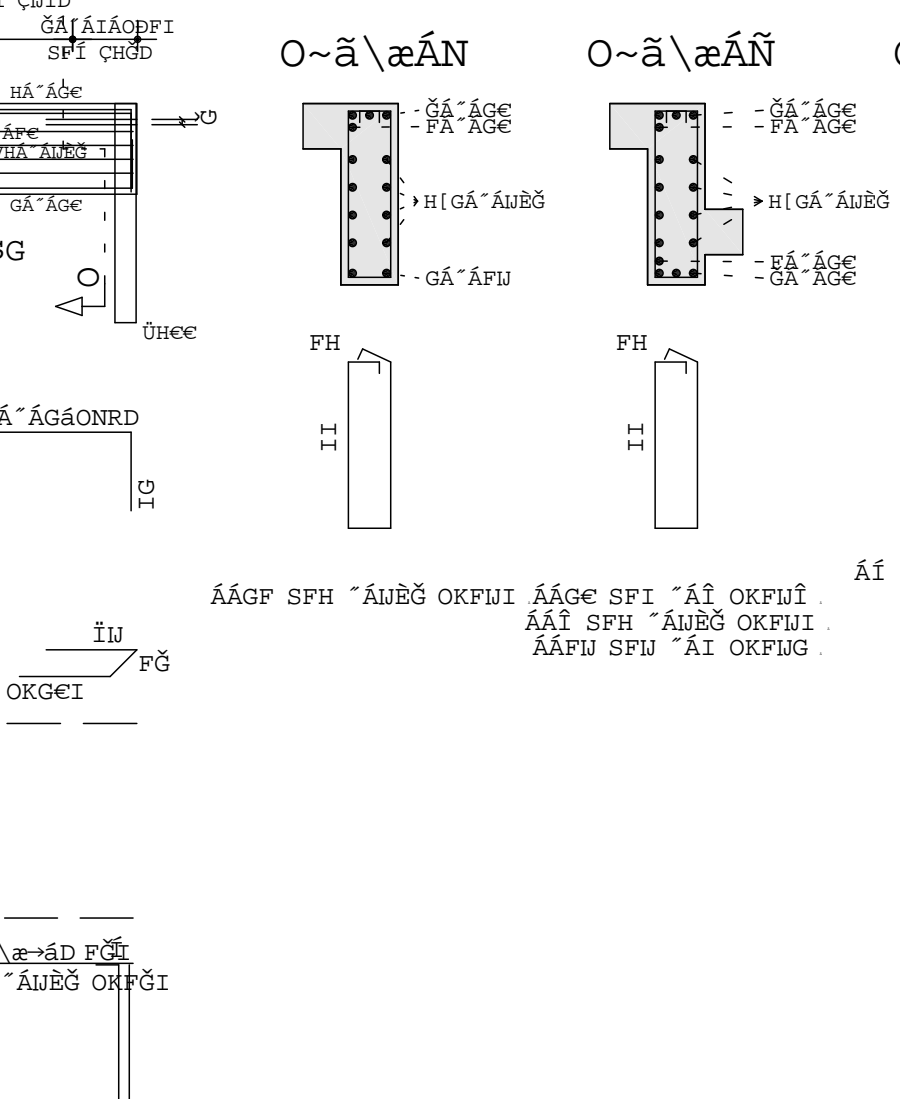
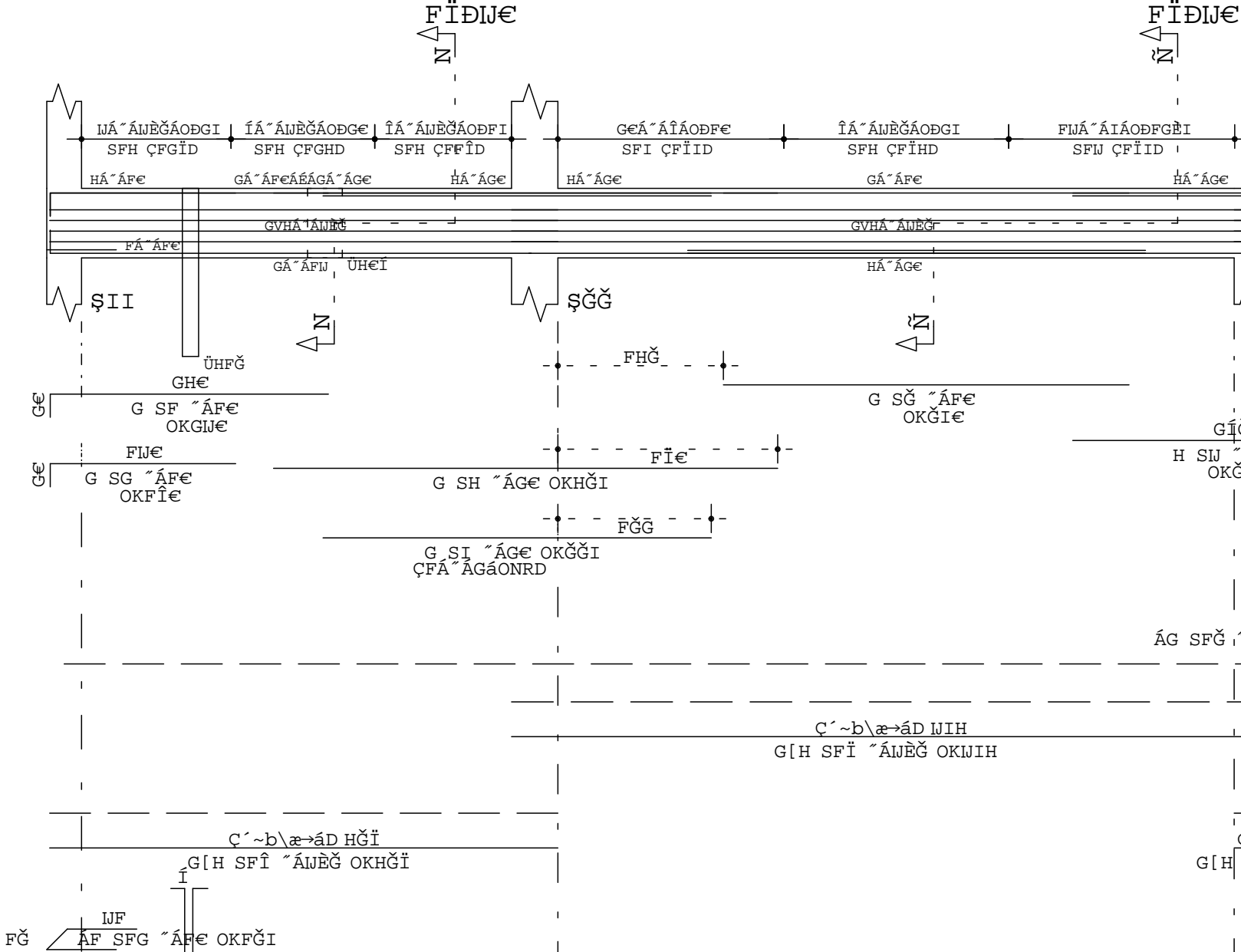

ÄÄi spõ "Äi okõõi" ÄÄi spõ "Äi okõõi" ÄÄi spõ "Äi okõõi"

ÜHGÏ

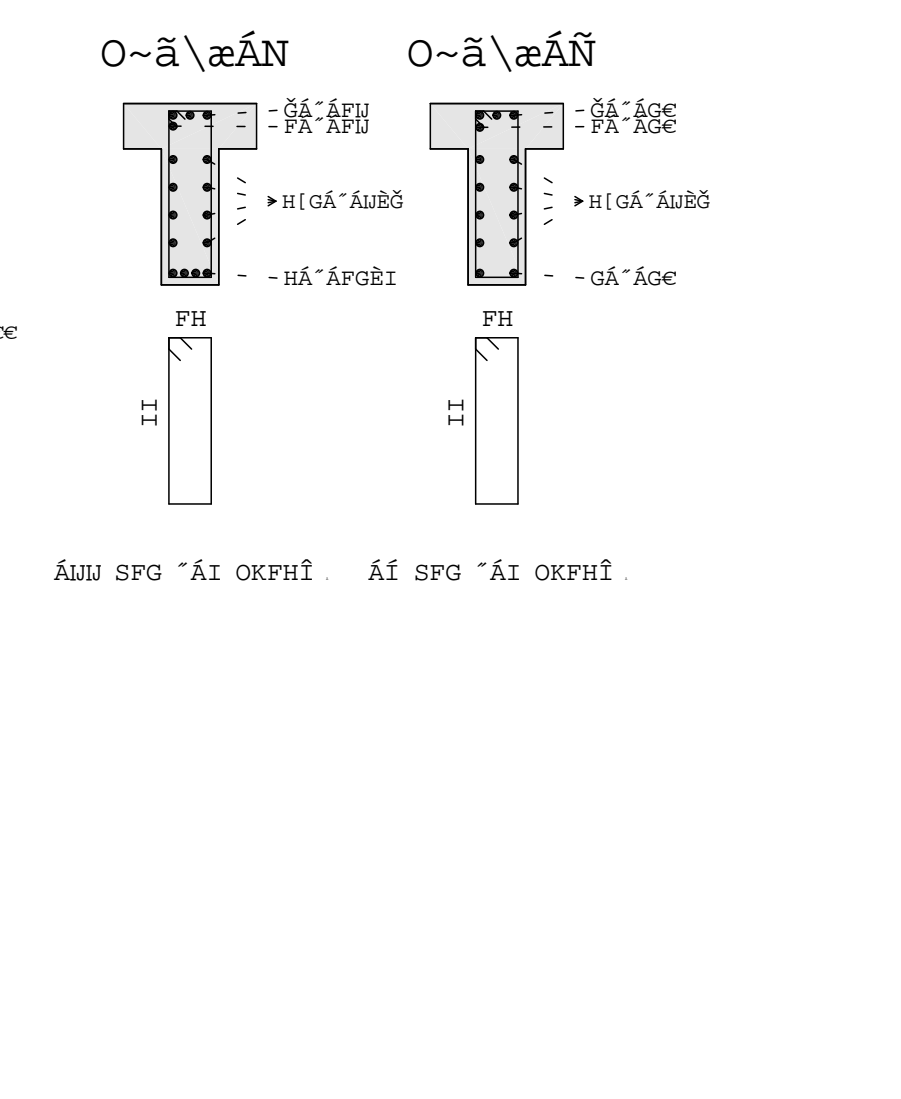
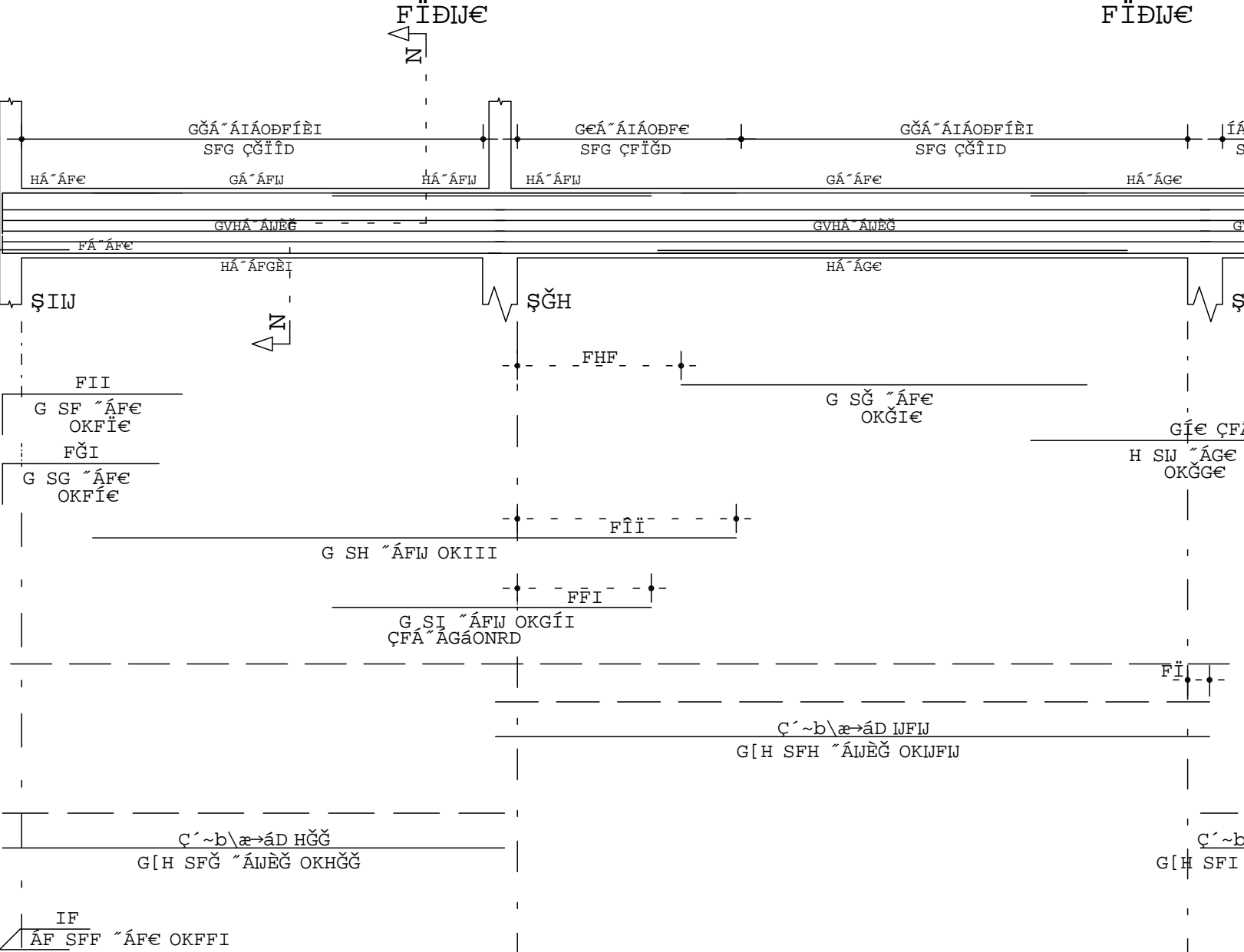

ÄÄi spõ "Äi okõõi" ÄÄi spõ "Äi okõõi"

ÜHGÏ

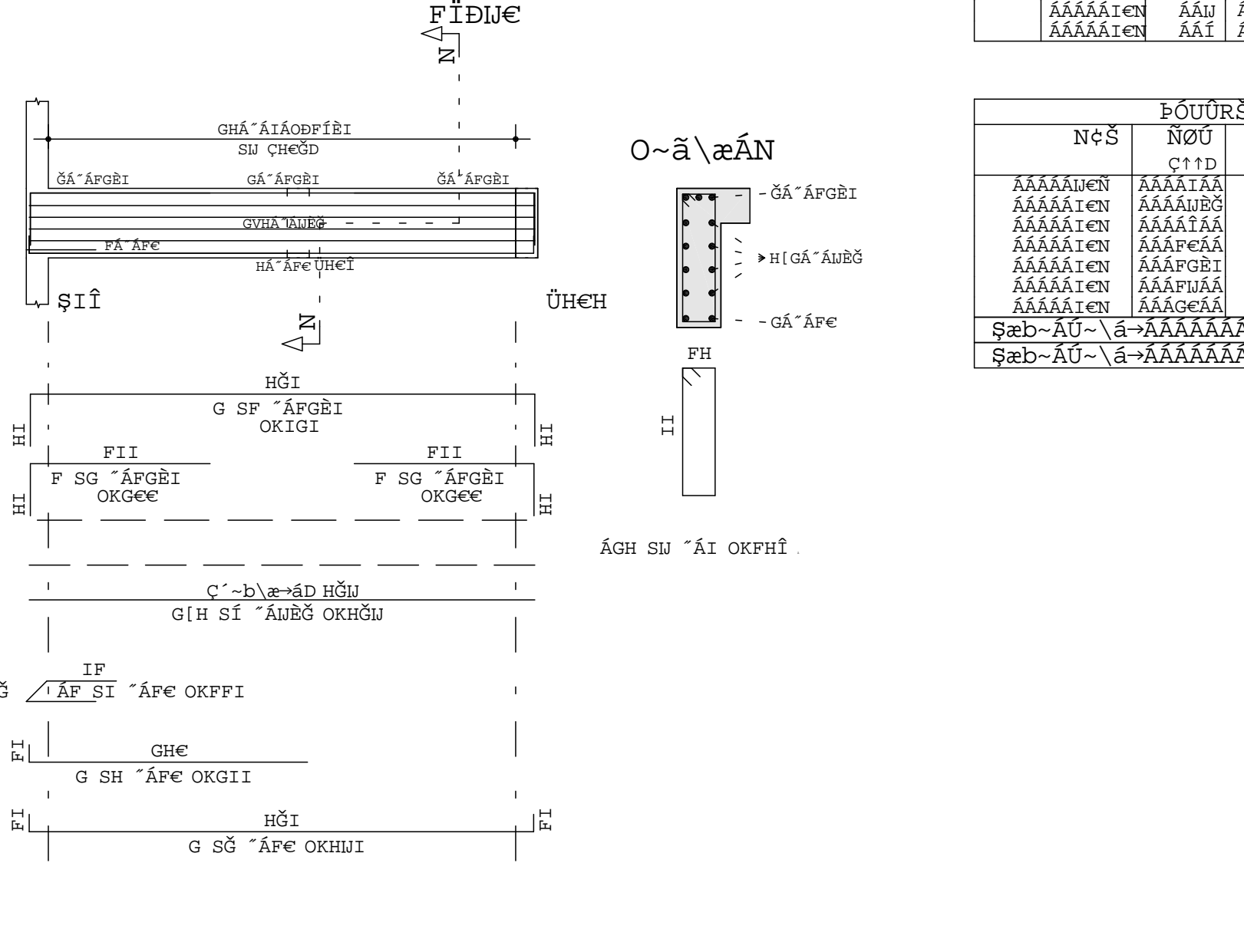

ÄÄi sh "Äi okõõi"

ÜHGÛ

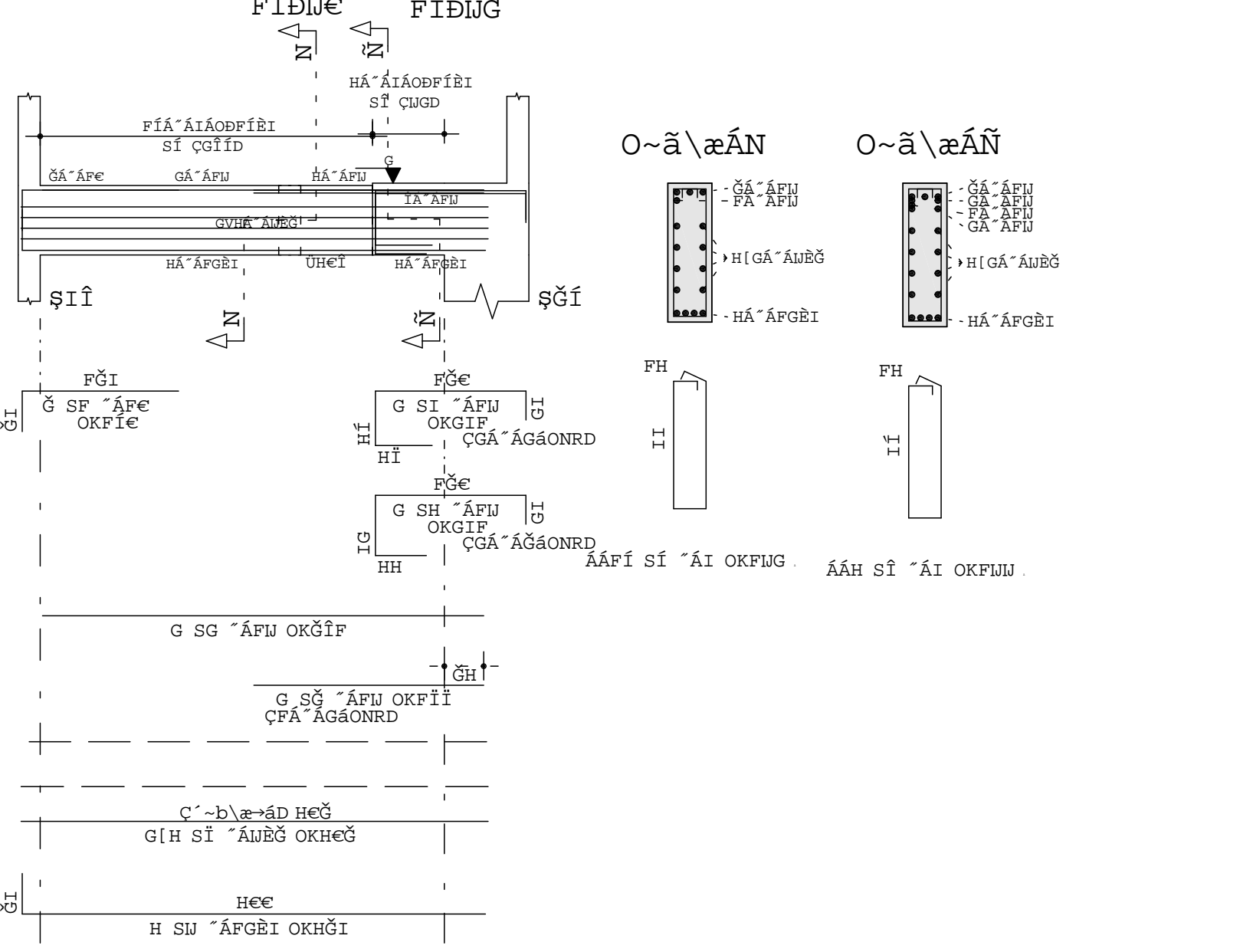

ÄÄi si "Äi okõõi" ÄÄi si "Äi okõõi"

Table with columns: NoS, SBU, NõU, TõNSU, OõRõPõRõGõS, GõUSU, GõUNõQ. Contains multiple rows of alphanumeric data.

Table with columns: NoS, NõU, OõRõPõ, GõUSU. Contains alphanumeric data.

Complex block containing technical diagrams, tables, and text. Includes a table with columns NoS, SBU, NõU, TõNSU, OõRõPõRõGõS, GõUSU, GõUNõQ. Also includes a table with columns NoS, NõU, OõRõPõ, GõUSU. Text includes 'ÜHFÏ' and 'GGF'.